



Operation **Manual**

DSV110 Servo Drive for Flying Shears



SHENZHEN INVT ELECTRIC CO., LTD.

Contents

Preface.....	i
Contents.....	ii
Chapter 1 Safety precautions.....	1
1.1 Safety definition.....	1
1.2 Warning signs.....	1
1.3 Safety guide.....	1
1.4 Scrap disposition.....	2
Chapter 2 Product overview.....	3
2.1 Product specifications.....	3
2.2 Name plate.....	5
2.3 Model code.....	5
2.4 Rated specifications.....	6
Chapter 3 Installation guide.....	8
3.1 Standard wiring of the main circuit.....	8
3.2 Standard wiring of the control circuit.....	9
Chapter 4 Keypad operation.....	15
4.1 Keypad introduction.....	15
4.2 Keypad display.....	17
4.3 Keypad operation.....	19
Chapter 5 Function parameters.....	22
Chapter 6 Basic operations.....	62
6.1 First power-on.....	62
6.2 Commissioning guide.....	62
Chapter 7 Fault tracking.....	66
7.1 Alarm and fault indications.....	66
7.2 Fault reset.....	66
7.3 Fault history.....	66
7.4 Servo drive faults and solutions.....	66
Chapter 8 Communication protocol.....	75
8.1 Introduction to the Modbus protocol.....	75
8.2 Application of Modbus.....	75
8.3 RTU command code and communication data.....	80
8.4 Common communication faults.....	95
Appendix A Extension cards.....	97
A.1 Optional PROFIBUS cards.....	97
A.2 Optional CANopen cards.....	97
Appendix B Technical data.....	98
B.1 Grid specifications.....	98
B.2 Motor connection data.....	98
B.3 Application standards.....	98
B.4 EMC regulations.....	99
Appendix C Dimension diagrams.....	101
C.1 Keypad structure.....	101
C.2 Dimension diagrams.....	102
Appendix D Optional peripheral accessories.....	104
D.1 Wiring of peripheral accessories.....	104
D.2 Capacitor components.....	106
D.3 Brake resistors.....	112









Chapter 1 Safety precautions

1.1 Safety definition

Danger:	Serious physical injury or even death may occur if related requirements are not followed.
Warning:	Physical injury or damage to the devices may occur if related requirements are not followed.
Note:	Steps to take for ensuring the proper running of the servo drive.
Trained and qualified electricians:	People working on the device must have taken part in professional electrical and safety training, obtained the certification, and been familiar with all steps and requirements of installing, commissioning, operating and maintaining the device, and are capable of preventing or dealing with all kinds of emergencies.



1.2 Warning signs

Warning signs are used to warn you about the conditions that may cause severe injury or damage to the device. They instruct you to exercise caution to prevent danger. The following table describes the warning signs used in this manual.



Sign	Name	Description	Abbreviation
 Danger	Danger	Serious physical injury or even death may be caused if related requirements are not followed.	
 Warning	Warning	Physical injury or damage to the devices may be caused if related requirements are not followed.	
 Electrostatic discharge	Electrostatic discharge	Damage to the PCBA board may be caused if related requirements are not followed.	
 Hot sides	Hot sides	Sides of the device may become hot. Do not touch.	
Note	Note	Steps to take for ensuring the proper running of the device.	Note

1.3 Safety guide

	<ul style="list-style-type: none"> ✧ Only qualified electricians are allowed to operate the device. ✧ Do not perform any wiring, inspection, or component replacement
---	---

	<p>operations when power is applied. Before wiring or inspection, ensure all input power supplies are disconnected and wait for at least the waiting time designated on the servo drive, or ensure that the DC bus voltage is lower than 36 V. The following table describes the waiting time.</p> <table border="1" data-bbox="303 268 967 368"> <thead> <tr> <th colspan="2" data-bbox="303 268 698 304">Servo drive model</th> <th data-bbox="698 268 967 304">Min. waiting time</th> </tr> </thead> <tbody> <tr> <td data-bbox="303 304 501 336">380 V</td> <td data-bbox="501 304 698 336">1.5 kW–110kW</td> <td data-bbox="698 304 967 336">5 min</td> </tr> <tr> <td data-bbox="303 336 501 368">380 V</td> <td data-bbox="501 336 698 368">132 kW–315 kW</td> <td data-bbox="698 336 967 368">15 min</td> </tr> </tbody> </table>	Servo drive model		Min. waiting time	380 V	1.5 kW–110kW	5 min	380 V	132 kW–315 kW	15 min
Servo drive model		Min. waiting time								
380 V	1.5 kW–110kW	5 min								
380 V	132 kW–315 kW	15 min								
	<p>⋄ Do not refit the product unauthorizedly; otherwise fire, electric shock or other injury may occur.</p>									
	<p>⋄ High-temperature components or parts may become hot when the device is running. Do not touch them. Otherwise, you may get burnt.</p>									
	<p>⋄ The electrical parts and components inside the product are electrostatic sensitive parts. Take measurements to prevent electrostatic discharge when performing operations involved with them.</p>									

1.4 Scrap disposition

	<p>⋄ There is heavy metal in the product. Deal with it as industrial waste.</p>
	<p>⋄ When the life cycle ends, the product should enter the recycling system. Dispose of it separately at an appropriate collection point instead of placing it in the normal waste stream.</p>

Chapter 2 Product overview

2.1 Product specifications

Function		Specification
Power input	Input voltage (V)	AC 3PH 380V (-15%)–440V (+10%)
	Input current (A)	Refer to section 2.4 "Rated specifications".
	Input frequency (Hz)	50 Hz or 60 Hz; allowable range: 47 Hz to 63 Hz
Power output	Output voltage (V)	0–input voltage
	Output current (A)	Refer to section 2.4 "Rated specifications".
	Output power (kW)	Refer to section 2.4 "Rated specifications".
	Output frequency (Hz)	0–400Hz
Technical control performance	Control mode	Space Vector Pulse Width Modulation (SVPWM), vector control with PG
	Motor type	Asynchronous motor, permanent-magnet synchronous motor (PMSM)
	Speed control accuracy	±0.02%
	Speed fluctuation	±0.1%
	Torque responsiveness	< 5ms
	Torque control accuracy	5%
	Start torque	0 Hz/200%
	Overload capacity	150% of the rated current: 60s 180% of the rated current: 10s 200% of the rated current: 1s
Peripheral interface	Terminal analog input resolution	≤ 20 mV
	Terminal digital input resolution	≤ 2 ms
	Analog input	3 inputs: AI1 and AI2: 0–10 V/0–20 mA AI3: -10–+10 V

Function		Specification
	Analog output	2 inputs: AO1 and AO2: 0–10 V/0–20 mA
	Digital input	9 inputs: 8 common inputs with a maximum frequency of 1 kHz and internal impedance of 3.3 k Ω 1 high-speed input with a maximum frequency of 50 kHz
	Digital output	2 outputs: 1 high-speed pulse output with a maximum frequency of 50 kHz 1 Y terminal open collector output
	Relay output	2 programmable relay outputs RO1A is in the normally open (NO) state, RO1B is in the normally closed (NC) state, and RO1C is the common terminal. RO2A is in the NO state, RO1B is in the NC state, and RO1C is the common terminal. Contact capacity: 3 A/AC 250 V, 1 A/DC 30 V
Flying shear-dedicated function	Cam profile	Supporting the sine flying cutting cam profile
	Signals of color code sensor	Supporting high-speed capture through hardware IO ports
	cutting point photoelectric sensor	For direct-driven flying shears, Z pulses of the motor can be used as cutting point signals.
	Speed of cutter	Supporting a maximum speed of 600 m/min; supporting cutter inertia autotuning and auto compensation, which improve the accuracy of the high-speed cutting
	Cutting accuracy	Max. accuracy: ± 0.5 mm
	Dual-drive cutting	Supporting dual-motor driving for double cutters
	Other function	Supporting the changing of the cutting length and synchronization area angle during the running, the increasing of the speed at the synchronization area, the cutting profile, and pre-alarm for cutting quantity

Function		Specification
Others	Installation mode	Supporting three installation modes, including the wall-mounting, floor installation, and flange installation modes
	Ambient temperature during running	-10—+50°C, derating at temperature higher than 40°C
	Ingress Protection (IP) rating	IP20
	Class of pollution	Class 2
	Cooling mode	Forced-air cooling
	Brake unit	Built-in brake units are equipped for servo drives of 380 V, 30 kW or lower. External brake units are optional for servo drives of 380 V, 37 kW or higher and 660 V.
	EMC filter	All products of the 380 V series can meet the C3 requirements stipulated in IEC61800-3. External filters that meet the C2 requirements stipulated in IEC61800-3 are optional.

2.2 Name plate

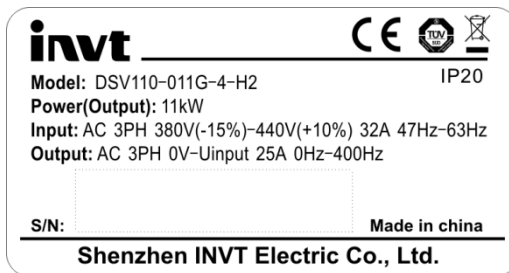

Figure 2-1 Name plate

2.3 Model code

The model code contains product information about the servo drive. You can find the model code from the name plate on the servo drive or the simplified name plate.

DSV110 – 5R5G – 4 – H2

① ② ③ ④

Figure 2-2 Model description

Field	Identifier	Field description	Detailed description
Product series abbreviation	①	Product series abbreviation	DSV110: Servo drive for flying shears
Rated power	②	Power range+load type	5R5: 5.5 kW G: Heavy load
Voltage class	③	Voltage class	4: AC 3PH 380 V (-15%)–440 V (+10%) Rated voltage: 380 V
Management No.	④	Market management No.	H2: Supporting 5 V high-speed differential signal input of an incremental encode, orthogonal pulse input, and magnetic pole detection UWW signal input S1: Supporting sin/cos encoders (1Vpp) such as Heidenhain ERN 1387, and orthogonal pulse input

2.4 Rated specifications

Product model	Output power (kW)	Input current (A)	Output current (A)	Carrier frequency (kHz)
DSV110-004G-4-H2/S1	4	13.5	9.5	1–15(8)
DSV110-5R5G-4-H2/S1	5.5	19.5	14	1–15(8)
DSV110-7R5G-4-H2/S1	7.5	25	18.5	1–15(8)
DSV110-011G-4-H2/S1	11	32	25	1–15(8)
DSV110-015G-4-H2/S1	15	40	32	1–15(4)
DSV110-018G-4-H2/S1	18.5	47	38	1–15(4)
DSV110-022G-4-H2/S1	22	56	45	1–15(4)
DSV110-030G-4-H2/S1	30	70	60	1–15(4)
DSV110-037G-4-H2/S1	37	80	75	1–15(4)
DSV110-045G-4-H2/S1	45	94	92	1–15(4)
DSV110-055G-4-H2/S1	55	128	115	1–15(4)
DSV110-075G-4-H2/S1	75	160	150	1–15(2)
DSV110-090G-4-H2/S1	90	190	180	1–15(2)
DSV110-110G-4-H2/S1	110	225	215	1–15(2)
DSV110-132G-4-H2/S1	132	265	260	1–15(2)
DSV110-160G-4-H2/S1	160	310	305	1–15(2)
DSV110-185G-4-H2/S1	185	345	340	1–15(2)
DSV110-200G-4-H2/S1	200	385	380	1–15(2)
DSV110-220G-4-H2/S1	220	430	425	1–15(2)
DSV110-250G-4-H2/S1	250	460	480	1–15(2)
DSV110-280G-4-H2/S1	280	500	530	1–15(2)
DSV110-315G-4-H2/S1	315	580	600	1–15(2)

Note:

-
1. The input currents of the servo drives of 4 to 315 kW are measured at the input voltage of 380 V, without DC reactors or input/output reactors.
 2. The rated output current is defined as the output current measured at the output voltage of 380 V.

Chapter 3 Installation guide

3.1 Standard wiring of the main circuit

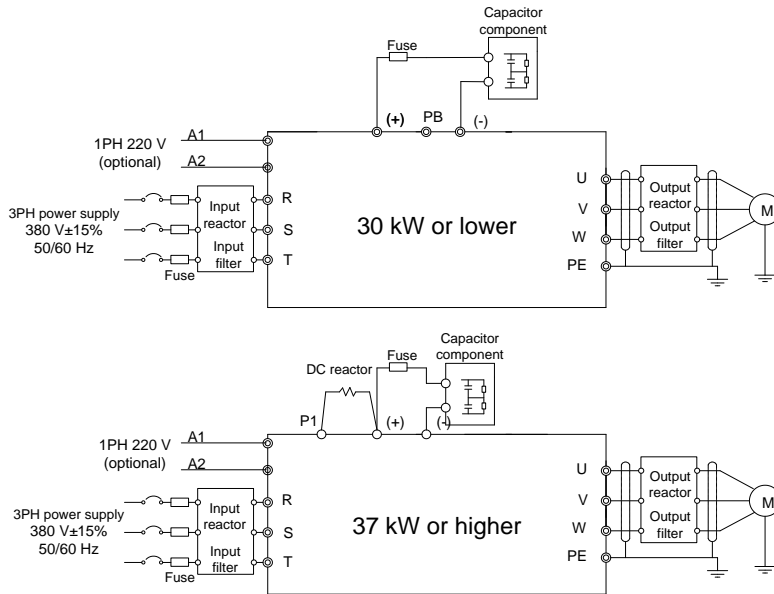

Figure 3-1 Standard wiring of the main circuit

Note:

1. The fuse, DC reactor, brake unit, brake resistor, input reactor, input filter, output reactor, and output filter are all optional accessories.
2. A1 and A2 are optional accessories.
3. For servo drives of 380 V, 37 kW or higher, the P1 and (+) terminals are shorted in factory. If you need to connect an external DC reactor, remove the short-circuit connector between the P1 and (+) terminals.
4. Before connecting a brake resistor, remove the yellow warning labels PB, (+), and (-) from the terminal block. Otherwise, poor contact may be caused.
5. You can also select optional capacitor components for servo drives of 380 V, 30 kW or lower.

3.2 Standard wiring of the control circuit

3.2.1 Wiring diagram of the control circuit

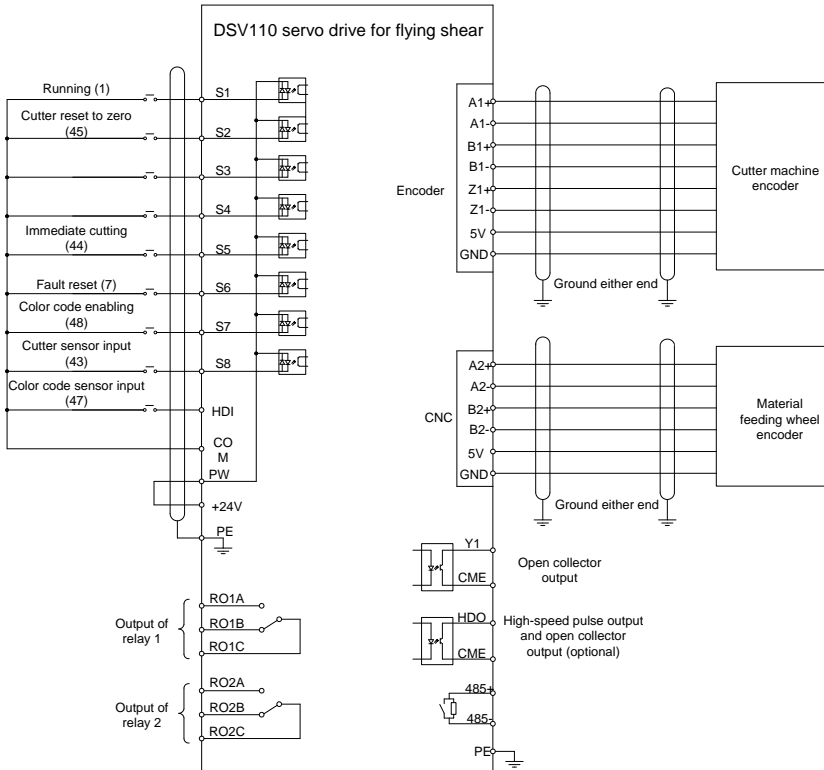

Figure 3-2 Wiring diagram of the control circuit

Terminal name	Description
+10V	Used by the servo drive to provide power of +10 V
AI1	1. Input range: For AI1 and AI2, the voltage and current ranges are 0 V to 10 V and 0 mA to 20 mA, respectively. AI1 is switched between voltage and current outputs through J3, and AI2 through J4. For AI3, the voltage range is -10 V to +10 V. 2. Input impedance: 20 kΩ for voltage input, and 500 Ω for current input 3. Resolution: The minimum resolution is 5 mV when 10 V corresponds to 50 Hz. 4. Deviation: ±1% at the temperature of 25°C
AI2	
AI3	
GND	Zero potential reference of +10 V

Terminal name	Description
AO1	1. Output range: Output voltage of 0–10 V or output current of 0–20 mA; voltage and current outputs are switched through jumpers; AO1 is switched through J1, and AO2 is switched through J2. 2. Deviation: $\pm 1\%$ at the temperature of 25°C
AO2	
RO1A	RO1 is relay output. RO1A is normally open (NO), RO1B is normally closed (NC), and RO1C is a common terminal. Contact capacity: 3 A/AC 250 V, 1 A/ DC 30 V
RO1B	
RO1C	
RO2A	RO2 is relay output. RO2A is NO, RO2B is NC, and RO2C is a common terminal. Contact capacity: 3 A/ AC 250 V, 1 A/ DC 30 V
RO2B	
RO2C	
HDO	1. Switch capacity: 200 mA/30 V 2. Output frequency range: 0–50 kHz
COM	Common terminal of +24 V
CME	Common terminal of the open collector output
Y	1. Switch capacity: 200 mA/30 V 2. Output frequency range: 0–1 kHz
485+	485 communication port and 485 differential signal port For standard 485 communication ports, use twisted pairs or shielded cables.
485-	
PE	Ground terminal
PW	Used by an external source to provide the working power of digital input Voltage range: 12–24 V
24V	Used by the servo drive to provide power for users Max. output current: 200 mA
COM	Common terminal of +24 V
S1	1. Internal impedance: 3.3 k Ω 2. Allowable voltage input: 12–30 V 3. Bidirectional input terminal, supporting both the NPN and PNP connection modes 4. Max. input frequency: 1 kHz 5. All these terminals are programmable digital input terminals, and you can set the function of each terminal through corresponding function codes.
S2	
S3	
S4	
S5	
S6	
S7	
S8	
HDI	Except the functions of S1 to S8, this terminal can also function as a high-frequency pulse input channel. Max. input frequency: 50 kHz

3.2.2 Description of S1-type terminals (EC-PG302-05)

1. S1 terminal block arrangement

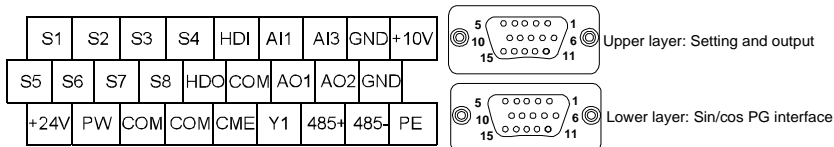

2. Definition of S1 terminal DB15 pins

DB15 (upper layer)	Pulse setting and output interface signal	DB15 (lower layer)	Sin/cos PG interface signal
1	AO+	1	B-
2	AO-	2	Null
3	BO+	3	R+
4	BO-	4	R-
5	ZO+	5	A+
6	ZO-	6	A-
7	/	7	0V
8	0V	8	B+
9	/	9	5V
10	+5V	10	C-
11	A2+	11	C+
12	A2-	12	D+
13	B2+	13	D-
14	B2-	14	Null
15	/	15	Null

3. Description of functions of S1 terminal DB15 pins

Upper-layer terminal name (pulse setting interface)	Description
A2+, A2-, B2+, B2-	5 V differential orthogonal pulse setting signal, supporting a maximum of 400 kHz
AO+, AO-, BO+, BO-, ZO+, ZO-	Frequency-divided output of encoder pulse signals at the division ratio of 1:1
Upper-layer terminal name (sin/cos encoder interface)	Description
+5V, 0V	Used to supply power for the encoder Allowed range: 5 V \pm 5%, 200 mA
A+, A-, B+, B-, C+, C-, D+, D-, R+, R-	Sin/cos encoder signal input, supporting SINA/SINB/SINC/SIND 0.8–1.2Vpp, SINR 0.2–0.85Vpp, and a maximum of 200 kHz

3.2.3 Description of H2-type terminals

1. H2 terminal block arrangement

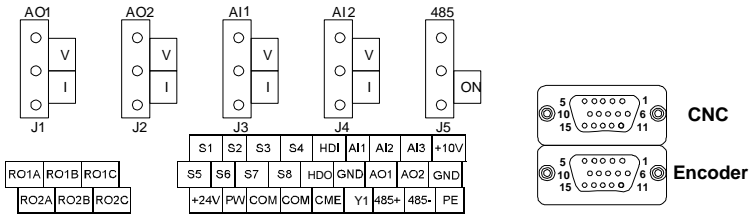

2. Definition of H2 terminal DB15 pins

DB15 (CNC)	Numerical control system interface signal	DB15 (Encoder)	Encoder interface signal
1	AO+	1	+5V
2	AO-	2	A1+
3	BO+	3	B1+
4	BO-	4	Z1+
5	ZO+	5	U+
6	ZO-	6	U-
7	CME	7	V+
8	GND	8	V-
9	S7	9	GND
10	+5V	10	A1-
11	A2+	11	B1-
12	A2-	12	Z1-
13	B2+	13	W+
14	B2-	14	W-
15	COM	15	

3. Description of functions of H2 terminal DB15 pins

Terminal name (CNC)	Description
A2+, A2-, B2+, B2-	5 V differential orthogonal pulse setting signal, supporting a maximum of 400 kHz
AO+, AO-, BO+, BO-, ZO+, ZO-	Frequency-divided output of encoder pulse signals at the division ratio of 1:1
CME, COM	Alarm output (to use this function, you need to short the Y terminal to +24V and remove the short-circuit connector between CME and COM)
S7	Common digital input
Terminal name (encoder)	Description
+5V, GND	Used to supply power for the encoder

	Allowed range: 5 V±5%, 200 mA
A1+, A1-, B1+, B1-, Z1+, Z1-	Differential input signals of encoders, supporting a maximum of 400 kHz
U+, U-, V+, V-, W+, W-	Differential angle signal input of UVW-type encoders (incremental encoders do not have to be connected to them)

3.2.4 Input/output signal connection diagrams

Use U-shaped short-circuit connectors to set the NPN or PNP mode and internal or external power supply. The NPN mode and internal power supply are set in factory.

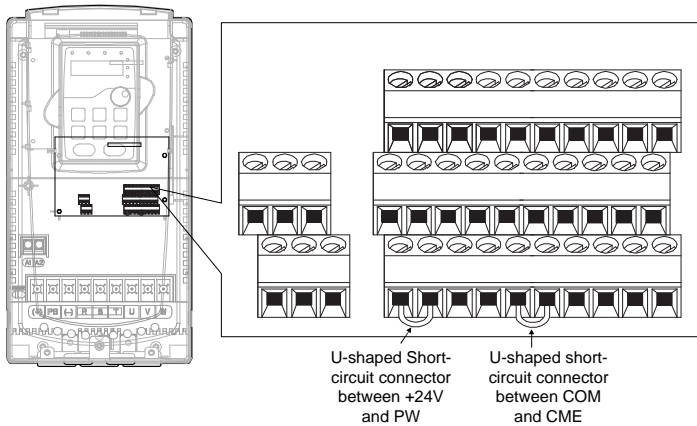

Figure 3-3 Positions of U-shaped short-circuit connectors

If input signals are transmitted by an NPN transistor, set the U-shaped short-circuit connector between +24V and PW as follows according to the power supply used.

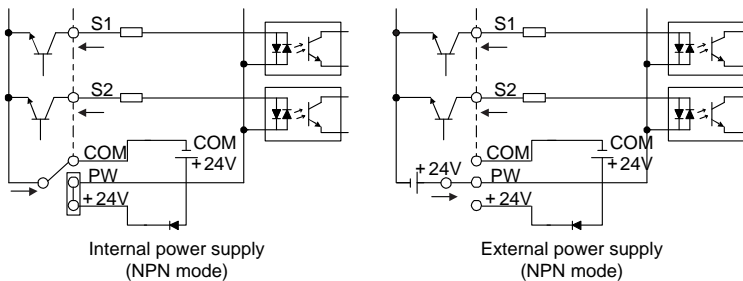

Figure 3-4 NPN modes

If input signals are transmitted by a PNP transistor, set the U-shaped short-circuit connector as follows according to the power supply used.

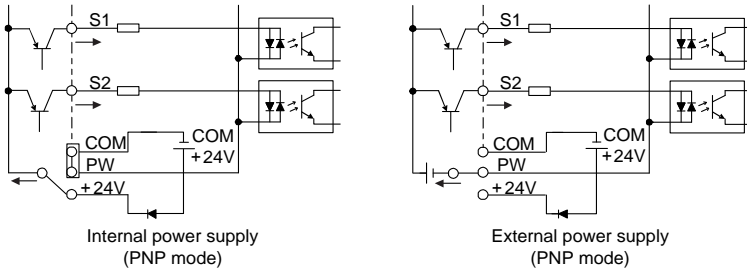

Figure 3-5 PNP modes

Chapter 4 Keypad operation

4.1 Keypad introduction

The keypad is used to control the DSV110 flying shear-dedicated servo drive, read the state data, and modify parameters.

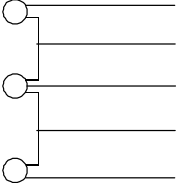









Figure 4-1 Keypad diagram

Note:

1. The standard configuration is LED keypad, but you can choose an optional LCD keypad. The LED keypad supports the display in multiple languages, provides the parameter copying function, and supports 10-line high-definition display. The installation dimensions of the LCD keypad are the same as that of the LED keypad.
2. When installing a keypad externally, you can directly use M3 thread screws to fix it or use a keypad mounting bracket. Standard keypad mounting brackets are provided for servo drives of 380 V, 37 to 500 kW and 660 V. For those of 380 V, 1.5 to 30 kW, keypad mounting brackets are optional, and you need to purchase them if required.

SN	Name	Description	
1	State indicator	RUN/TUNE	If the indicator is off, the servo drive is in the stop state; if the indicator blinks, parameter autotuning is being performed; and if the indicator is on, the servo drive is in the running state.
		FWD/REV	Forward/reverse running indicator If the indicator is off, the servo drive is in the forward running state; and if the indicator is on, the servo drive is in the reverse running state.
		LOCAL/REMOT	Keypad-, terminal-, and remote

SN	Name	Description																																																																							
			communication-based control indicator If the indicator is off, the control is based on keypad; if the indicator blinks, the control is based on terminals; and if the indicator is on, the control is based on remote communication.																																																																						
		TRIP	Fault indicator If the indicator is on, the servo drive is in the faulty state; if the indicator is off, the servo drive runs properly; and if the indicator blinks, the servo drive is in the pre-alarm state.																																																																						
2	Unit indicator	Indicates the unit displayed on the keypad.																																																																							
			Hz	Frequency unit																																																																					
			RPM	Rotating speed unit																																																																					
			A	Current unit																																																																					
			V	Voltage unit																																																																					
3	Digital display	Five-digit LED display, displaying various monitored data such as the set frequency and output frequency, and alarm codes.																																																																							
		<table border="1" style="width: 100%; border-collapse: collapse;"> <thead> <tr> <th style="width: 16.6%;">Displayed character</th> <th style="width: 16.6%;">Corresponding character</th> <th style="width: 16.6%;">Displayed character</th> <th style="width: 16.6%;">Corresponding character</th> <th style="width: 16.6%;">Displayed character</th> <th style="width: 16.6%;">Corresponding character</th> </tr> </thead> <tbody> <tr> <td style="text-align: center;">0</td> <td style="text-align: center;">0</td> <td style="text-align: center;">1</td> <td style="text-align: center;">1</td> <td style="text-align: center;">2</td> <td style="text-align: center;">2</td> </tr> <tr> <td style="text-align: center;">3</td> <td style="text-align: center;">3</td> <td style="text-align: center;">4</td> <td style="text-align: center;">4</td> <td style="text-align: center;">5</td> <td style="text-align: center;">5</td> </tr> <tr> <td style="text-align: center;">6</td> <td style="text-align: center;">6</td> <td style="text-align: center;">7</td> <td style="text-align: center;">7</td> <td style="text-align: center;">8</td> <td style="text-align: center;">8</td> </tr> <tr> <td style="text-align: center;">9</td> <td style="text-align: center;">9</td> <td style="text-align: center;">A</td> <td style="text-align: center;">A</td> <td style="text-align: center;">b</td> <td style="text-align: center;">b</td> </tr> <tr> <td style="text-align: center;">C</td> <td style="text-align: center;">C</td> <td style="text-align: center;">d</td> <td style="text-align: center;">d</td> <td style="text-align: center;">E</td> <td style="text-align: center;">E</td> </tr> <tr> <td style="text-align: center;">F</td> <td style="text-align: center;">F</td> <td style="text-align: center;">H</td> <td style="text-align: center;">H</td> <td style="text-align: center;">I</td> <td style="text-align: center;">I</td> </tr> <tr> <td style="text-align: center;">L</td> <td style="text-align: center;">L</td> <td style="text-align: center;">N</td> <td style="text-align: center;">N</td> <td style="text-align: center;">n</td> <td style="text-align: center;">n</td> </tr> <tr> <td style="text-align: center;">O</td> <td style="text-align: center;">O</td> <td style="text-align: center;">P</td> <td style="text-align: center;">P</td> <td style="text-align: center;">r</td> <td style="text-align: center;">r</td> </tr> <tr> <td style="text-align: center;">S</td> <td style="text-align: center;">S</td> <td style="text-align: center;">t</td> <td style="text-align: center;">t</td> <td style="text-align: center;">U</td> <td style="text-align: center;">U</td> </tr> <tr> <td style="text-align: center;">V</td> <td style="text-align: center;">V</td> <td style="text-align: center;">.</td> <td style="text-align: center;">.</td> <td style="text-align: center;">-</td> <td style="text-align: center;">-</td> </tr> </tbody> </table>	Displayed character	Corresponding character	Displayed character	Corresponding character	Displayed character	Corresponding character	0	0	1	1	2	2	3	3	4	4	5	5	6	6	7	7	8	8	9	9	A	A	b	b	C	C	d	d	E	E	F	F	H	H	I	I	L	L	N	N	n	n	O	O	P	P	r	r	S	S	t	t	U	U	V	V	.	.	-	-					
		Displayed character	Corresponding character	Displayed character	Corresponding character	Displayed character	Corresponding character																																																																		
		0	0	1	1	2	2																																																																		
		3	3	4	4	5	5																																																																		
		6	6	7	7	8	8																																																																		
		9	9	A	A	b	b																																																																		
		C	C	d	d	E	E																																																																		
		F	F	H	H	I	I																																																																		
		L	L	N	N	n	n																																																																		
		O	O	P	P	r	r																																																																		
		S	S	t	t	U	U																																																																		
V	V	.	.	-	-																																																																				
4	Digital	Used to adjust the frequency. For details, see the description of the function																																																																							

SN	Name	Description		
	potentiometer	code P08.42.		
5	Buttons		Programming key	Enter or exit from the Level-1 menus; or delete a parameter.
			Enter key	Enter menus in cascading mode; or confirm the setting of a parameter.
			UP key	Increase data or the function code progressively.
			DOWN key	Decrease data or the function code progressively.
			Right-shifting key	On the interface displayed when the machine is stopped or running, press this key to select, from left to right, the parameter to be displayed; or press this key to select the digit of a parameter during parameter modification.
			Run key	In the keypad-based operation mode, press this key to run the machine.
			Stop/Reset key	In running state, press this key to stop the machine. This function is restricted by P07.04. In the fault alarm state, this key can be used to reset the machine in all control modes.
	Functional shortcut key	The function of this key is determined by P07.02.		

4.2 Keypad display

The keypad of the DSV110 flying shear-dedicated servo drive may display the stop state parameters, running state parameters, function code parameter editing states, and fault alarm states.

4.2.1 Parameters displayed in the stop state

When the servo drive is in the stop state, the keypad displays a parameter, as shown in Figure 4-2.

Multiple state parameters can be displayed in the stop state. You can set a parameter to be displayed by setting the binary bits of P07.07. For definitions of the bits, see the description of P07.07.

Parameters that can be selected to be displayed in the stop state include the set frequency, bus voltage, input terminal state, output terminal state, set torque, AI1, AI2, and AI3. Whether a parameter

is to be displayed is set through the bits (transformed into binary bits) of P07.07.

Press **>>/SHIFT** to shift the display of the selected parameters from left to right, and press **QUICK/JOG** (P07.02=2) to shift from right to left.

4.2.2 Parameters displayed in the running state

After receiving a valid running command, the servo drive enters the running state, and a parameter is displayed on the keypad. The **RUN/TUNE** indicator is on, and the on/off state of the **FWD/REV** indicator is determined by the running direction of the servo drive, as shown in Figure 4-2.

Parameters that can be selected to be displayed in the running state include the running frequency, set frequency, bus voltage, output voltage, output current, running speed, output power, output torque, input terminal state, output terminal state, set torque, AI1, AI2, AI3, high-speed pulse HDI frequency, motor overload percentage, servo drive overload percentage, and ramp frequency reference. Whether a parameter is to be displayed is set through the bits (transformed into binary bits) of P07.05 and P07.06.

Press **>>/SHIFT** to shift the display of the selected parameters from left to right, and press **QUICK/JOG** (P07.02=2) to shift from right to left.

4.2.3 Information displayed in the faulty state

After detecting a fault signal, the servo drive enters the fault alarm state immediately, and the fault code blinks on the keypad. The **TRIP** indicator is on, and you can perform fault reset by using the **STOP/RST** key, control terminals, or communication commands.

If the fault still persists, the fault code is continuously displayed.

4.2.4 Function code editing

You can press the **PRG/ESC** key to enter the editing state in the stop, running, or fault alarm state (if a user password is used, see the description of P07.00). Editing states are displayed through two levels of menus in the following sequence: function code group or function code number → function code parameter. Press the **DATA/ENT** key to enter the function parameter display interface. On the function parameter display interface, press the **DATA/ENT** key to save the parameter settings, and the **PRG/ESC** key to exit from the parameter display interface.

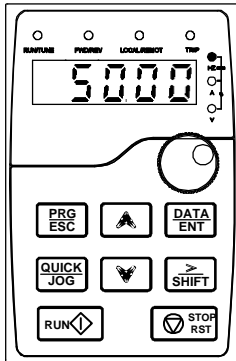

Parameters displayed in the stop state

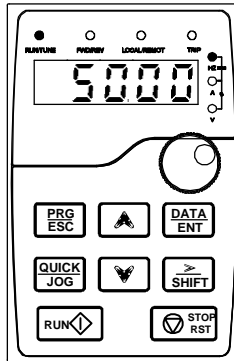

Parameters displayed in the running state

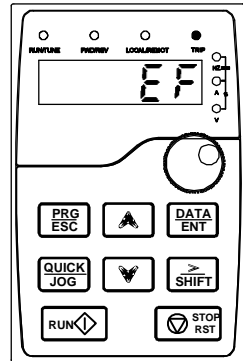

Information displayed in the faulty state

Figure 4-2 Keypad display

4.3 Keypad operation

You can perform various operations on the servo drive by using a keypad. For details about the structure of the function codes, see the function code table.

4.3.1 Function code modification

The servo drive provides three levels of menus, including:

- Function code group number (Level-1 menu)
- Function code number (Level-2 menu)
- Function code set value (Level-3 menu)

Description: When performing operations on the Level-3 menus, you can press the **PRG/ESC** or **DATA/ENT** key to return to the Level-2 menu. If you press the **DATA/ENT** key, the set value of the parameter is saved to the control board before you return to the Level-2 menu, and then the next function code is displayed. If you press the **PRG/ESC** key, you return to the Level-2 menu directly, the set value of the parameter is not saved, and the current function code is displayed.

On Level-3 menus, if no digit of the parameter blinks, it indicates that the function code cannot be modified due to the following possible reasons:

1. The function code is an unmodifiable parameter, for example, a detected parameter or running recording parameter.
2. The function code cannot be modified in the running state, and can be modified after the machine is stopped.

Example: Change the value of P00.00 from **0** to **1**.

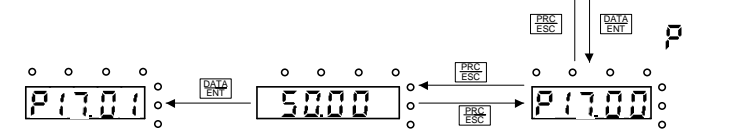
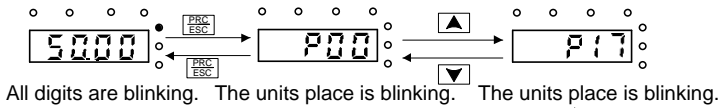

The units place is blinking. The units place is blinking. The units place is blinking.



Note: When setting the value, you can press  and  +  to modify the value.

Figure 4-5 Parameter viewing diagram

Chapter 5 Function parameters

The function parameters of DSV110 flying shear-dedicated servo drives are divided by function into 30 groups, P00 to P29. Each function group includes several function codes. Three levels of menus are applied for function codes. For example, "P08.08" indicates the 8th function code in the P08 group. The P29 group indicates factory functions, and you have no access to it.

To facilitate the settings of function codes, the function group numbers correspond to the Level-1 menus, the function codes correspond to the Level-2 menus, and the function code parameters correspond to the Level-3 menus.

1. The content of the function table is as follows:

Column 1 "Function code ": Code of the function group and parameter

Column 2 "Name": Full name of the function parameter

Column 3 "Detailed description": Detailed description of the function parameter

Column 4 "Default value": Initial value set in factory

Column 5 "Modify": Whether the function parameter can be modified, and conditions for the modification

"○" indicates that the value of the parameter can be modified when the servo drive is in the stop or running state.

"◎" indicates that the value of the parameter cannot be modified when the servo drive is in the running state.

"●" indicates that the value of the parameter is detected and recorded, and cannot be modified.

(The servo drive automatically checks and constrains the modification of parameters, which helps prevent incorrect modifications.)

2. The parameters adopt the decimal system (DEC). If the hexadecimal system is adopted, the data in each digit is independent from each other during parameter editing. The values of some of the digits can be hexadecimal (0–F).
3. "Default value" indicates the factory setting of the function parameter. If the value of the parameter is detected or recorded, the value cannot be restored to the factory setting.
4. To better protect the parameters, the servo drive provides the password protection function. After a password is set (that is, P07.00 is set to a non-zero value), "0.0.0.0.0" is displayed when you press the **PRG/ESC** key to enter the function code editing interface. You need to enter the correct user password to enter the interface. For the factory parameters, you need to enter the correct factory password to enter the interface. (You are advised not to modify the factory parameters. Incorrect parameter setting may cause operation exceptions or even damage to the servo drive.). When the system is not locked due to password protection, you can modify the password, and the last value entered is the user password. If P07.00 is set to 0, the user

password is canceled. If P07.00 is set to a non-zero value, the parameters are protected by the user password during servo drive power-on.

5. When you modify function parameters through serial communication, the user password provides the same functions.

Function code	Name	Detailed description	Default value	Modify
P00 group Basic functions				
P00.00	Speed control mode	0-1: Reserved 2: Space voltage vector control mode 3: Closed-loop vector control mode	3	◎
P00.01	Channel of running commands	Used to select the channel of control commands of the servo drive. The control commands of the servo drive include start, stop, forward running, reverse running, jogging, and fault reset. 0: Keypad ("LOCAL/REMOT" off) The running commands are controlled through the RUN and STOP/RST keys on the keypad. In the running state, if you press the RUN and STOP/RST keys at the same time, the servo drive coasts to stop. 1: Terminals ("LOCAL/REMOT" blinks) The running commands are controlled through the forward running, reverse running, forward jogging, reverse jogging functions of the multi-function input terminals. 2: Communication ("LOCAL/REMOT" on) The running commands are controlled by the upper computer in the communication mode.	0	○
P00.03	Max. output frequency	Used to set the maximum output frequency of the servo drive. Pay attention to this parameter. It determines the setting of the frequency and the speed of acceleration and deceleration. Setting range: P00.04-400.00 Hz	50.00 Hz	◎
P00.04	Upper limit of running frequency	Indicates the output frequency upper limit of the servo drive. The value cannot be greater than the value of P00.03 (Max. output frequency). When the set frequency is higher than this upper limit, the servo drive runs at this frequency upper limit.	50.00 Hz	◎

Function code	Name	Detailed description	Default value	Modify
		Setting range: P00.05–P00.03 (Max. output frequency)		
P00.06	Frequency A setting mode	<p>0: Keypad After this parameter is set to 0, you can set the frequency by modifying the value of P00.10 (Frequency set through keypad).</p> <p>1: Analog input AI1 2: Analog input AI2 3: Analog input AI3 4: High-speed pulse HDI 5–11: Reserved 12: Pulse strings A and B</p>	0	○
P00.10	Frequency set through keypad	<p>If Frequency A setting mode is set to 0 (Keypad), the value of this parameter is the initial digital setting of the frequency of the servo drive.</p> <p>Setting range: 0.00 Hz–P00.03 (Max. output frequency)</p>	10.00 Hz	○
P00.11	ACC time 1	<p>Indicates the time the servo drive takes to accelerate from 0 Hz to P00.03 (Max. output frequency).</p> <p>Setting range: 0.0–3600.0s</p>	Depend on model	○
P00.12	DEC time 1	<p>Indicates the time the servo drive takes to decelerate from P00.03 (Max. output frequency) to 0 Hz.</p> <p>Setting range: 0.0–3600.0s</p>	Depend on model	○
P00.13	Running direction	<p>0: Run in the default direction; the servo drive runs forward, and the FWD/REV indicator is off.</p> <p>1: Run in the reverse direction; the servo drive runs reversely, and the FWD/REV indicator is on.</p> <p>You can change the rotating direction of the motor by modifying this parameter. The modification equals adjusting any two lines of the motor lines (U, V, W) to change the rotating direction of the motor. You can also change the rotating direction of the motor through the QUICK/JOG key on the keypad. For details, see the description of P07.02.</p> <p>Note: After the function parameters are restored to the default values, the running direction of the motor is restored to the default value. Exercise caution</p>	2	○

Function code	Name	Detailed description	Default value	Modify
		<p>in scenarios where commissioning has been performed on the system and the rotating direction of the motor cannot be changed.</p> <p>2: No reverse running; the servo drive cannot run in the reverse direction. This value is applicable to some special scenarios where reverse running is forbidden.</p>		
P00.14	Carrier frequency	<p>The carrier frequency of the servo drive is set properly in factory. Generally, you do not need to modify this parameter. If the carrier frequency you set exceeds the default value, the servo drive needs to be derated by 10% for each increased 1 kHz.</p> <p>Setting range: 1.2–15.0 kHz</p>	Depend on model	○
P00.15	Motor parameter autotuning	<p>0: No operation</p> <p>1: Reserved</p> <p>2: Static autotuning (comprehensive autotuning); applicable to scenarios where the motor cannot be disconnected from the load.</p>	0	◎
P00.18	Function parameter restoration	<p>0: No operation</p> <p>1: Restore to the default values</p> <p>2: Delete fault files</p> <p>Note: After a selected operation is performed, this parameter is automatically restored to 0. Restoring to the default values may delete the user password. Exercise caution when using this function.</p>	0	◎
P01 group Start and stop control				
P01.08	Stop mode	<p>0: Decelerate to stop. After receiving a valid stop command, the servo drive stops in deceleration mode. It reduces the output frequency to 0 Hz in the defined DEC time and stops.</p> <p>1: Coast to stop. After receiving a valid stop command, the servo drive stops the output immediately, and the load coasts to stop based on the mechanical inertia.</p>	0	○
P01.25	Emergency stop DEC time	<p>Indicates the deceleration time in emergency stop (the terminal function is set to 56)</p> <p>Setting range: 0.0–60.0s</p>	2.0s	○

Function code	Name	Detailed description		Default value	Modify
P02 group Parameters of motor 1					
P02.00	Type of motor 1	0: Asynchronous motor 1: Synchronous motor		0	⊙
P02.01	Rated power of asynchronous motor 1	0.1–3000.0 kW	Parameters of the controlled asynchronous motor. To ensure the control performance, set P02.01–P02.05 correctly according to the information on the name plate of the asynchronous motor. The DSV110 flying shear-dedicated servo drive provides the parameter autotuning function. Whether parameter autotuning can be performed properly depends on the settings of the motor name plate parameters. In addition, you need to configure a motor based on the standard motor configuration of the servo drive. If the power of the motor is greatly different from that of the standard motor configuration, the control performance of the servo drive degrades significantly. Note: Resetting the rated power of the motor (P02.01) can initialize the parameters of P02.02 to P02.10.	Depend on model	⊙
P02.02	Rated frequency of asynchronous motor 1	0.01 Hz–P00.03 (Max. output frequency)		50.00Hz	⊙
P02.03	Rated rotating speed of asynchronous motor 1	1–36000rpm		Depend on model	⊙
P02.04	Rated voltage of asynchronous motor 1	0–1200V		Depend on model	⊙
P02.05	Rated current of asynchronous motor 1	0.8–6000.0A		Depend on model	⊙
P02.06	Stator resistance of asynchronous motor 1	0.001–65.535Ω	After motor parameter autotuning is properly performed, the values of P02.06 to P02.10 are automatically updated. These parameters are the reference parameters for high-performance vector control, directly affecting the control performance of the servo drive. Note: Do not modify these parameters	Depend on model	○
P02.07	Rotor resistance of asynchronous motor 1	0.001–65.535Ω		Depend on model	○
P02.08	Leakage inductance of asynchronous motor 1	0.1–6553.5mH		Depend on model	○

Function code	Name	Detailed description		Default value	Modify	
P02.09	Mutual inductance of asynchronous motor 1	0.1–6553.5mH	unless it is necessary.	Depend on model	○	
P02.10	Current of asynchronous motor 1 without load	0.1–6553.5A		Depend on model	○	
P02.15	Rated power of synchronous motor 1	0.1–3000.0kW	Parameters of the controlled synchronous motor. To ensure the control performance, set P02.15–P02.19 correctly according to the information on the name plate of the synchronous motor. The DSV110 flying shear-dedicated servo drive provides the parameter autotuning function. Whether parameter autotuning can be performed properly depends on the settings of the motor name plate parameters. In addition, you need to configure a motor based on the standard motor configuration of the servo drive. If the power of the motor is greatly different from that of the standard motor configuration, the control performance of the servo drive degrades significantly. Note: Resetting the rated power of the motor (P02.15) can initialize the parameters of P02.16 to P02.19.	Depend on model	◎	
P02.16	Rated frequency of synchronous motor 1	0.01Hz–P00.03 (Max. output frequency)		50.00Hz	◎	
P02.17	Number of pole pairs of synchronous motor 1	1–128		2	◎	
P02.18	Rated voltage of synchronous motor 1	0–1200V		Depend on model	◎	
P02.19	Rated current of synchronous motor 1	0.8–6000.0A		Depend on model	◎	
P02.20	Stator resistance of synchronous motor 1	0.001–65.535Ω		After motor parameter autotuning is properly performed, the values of P02.20 to P02.22 are automatically updated. These parameters are the reference parameters for high-performance vector control,	Depend on model	○
P02.21	D-axis inductance of synchronous	0.01–655.35mH			Depend on model	○

Function code	Name	Detailed description		Default value	Modify
	motor 1		directly affecting the control performance of the servo drive.		
P02.22	Q-axis inductance of synchronous motor 1	0.01–655.35mH	When P00.15 is set 1 (rotating autotuning), the value of P02.23 can be automatically updated through autotuning. In this case, you do not need to modify it. When P00.15 is set 2 (static autotuning), the value of P02.23 cannot be automatically updated through autotuning. In this case, you need to calculate its value and manually modify it.	Depend on model	○
P02.26	Overload protection of motor 1	<p>0: No protection</p> <p>1: Common motor (equipped with low-speed compensation) The heat dissipation performance of a common motor degrades when it runs at a low speed, and so the corresponding electronic thermal protection values need to be adjusted. The low-speed compensation described here is to reduce the overload protection threshold of the motor when it runs at a frequency lower than 30 Hz.</p> <p>2: Variable-frequency motor (without low-speed compensation) The heat dissipation performance of a variable-frequency motor is not affected by the rotating speed, and so the protection threshold does not need to be adjusted when the motor runs at a low frequency.</p>		2	◎
P02.27	Overload protection coefficient of motor 1	<p>Motor overload multiple $M = I_{out}/(I_n \times K)$</p> <p>$I_n$ is the rated current of the motor, I_{out} is the output current of the servo drive, and K is the motor overload protection coefficient.</p> <p>The smaller K is, the greater M is, and the more likely protection is implemented.</p> <p>When M is 116%, protection is implemented after the motor is overloaded for 1 hour; when M is 200%,</p>		100.0%	○

Function code	Name	Detailed description	Default value	Modify
		<p>protection is implemented after overload of 60s; and when M is equal to or higher than 400%, protection is implemented immediately.</p> <p>Setting range: 20.0%–120.0%</p>		

P03 group Vector control

P03.00	ASR proportional gain 1	<p>The parameters of P03.00 to P03.05 are applicable only to the vector control mode. When the frequency is lower than P03.02 (Low-point frequency for switching), the ASR PI parameters are P03.00 and P03.01. When the frequency is higher than P03.05 (High-point frequency for switching), the ASR PI parameters are P03.03 and P03.04. When the frequency is between P03.02 and P03.05, the PI parameters are obtained based on the linear change of these two parameters, as shown in the following figure.</p>	20.0	<input type="radio"/>
P03.01	ASR integral time 1		0.200s	<input type="radio"/>
P03.02	Low-point frequency for switching		5.00Hz	<input type="radio"/>
P03.03	ASR proportional gain 2		20.0	<input type="radio"/>
P03.04	ASR integral time 2		0.200s	<input type="radio"/>
P03.05	High-point frequency for switching	<p>You can adjust the dynamic response characteristics of the speed loop in vector control by setting the proportional gain and integral time of the automatic speed regulator (ASR). Both increasing the proportional gain and decreasing the integral time can accelerate the dynamic response of the speed loop. However, if the proportional gain is too large or the integral time is too short, oscillation to the system or overadjustment may be caused. If the proportional gain is too small, steady-state oscillation may be</p>	10.00Hz	<input type="radio"/>

Function code	Name	Detailed description	Default value	Modify
		easily caused to the system, and static speed error may also occur. The ASR PI parameters are closely related to the inertia of the system. The default PI parameters need to be modified based on the characteristics of loads to meet requirements of various scenarios. Setting range of P03.00: 0.0–200.0 Setting range of P03.01: 0.000–10.000s Setting range of P03.02: 0.00 Hz–P03.05 Setting range of P03.03: 0.0–200.0 Setting range of P03.04: 0.000–10.000s Setting range of P03.05: P03.02–P00.03(Max. output frequency)		
P03.06	ASR output filter	0–8 (corresponding to 0–2 ⁸ /10 ms)	0	○
P03.09	ACR proportional coefficient P	Note: These two parameters are the PI regulation parameters of the automatic current regulator (ACR). They directly affect the dynamic responding speed and control accuracy of the system. Generally for asynchronous machines, you do not need to modify their default values; and for synchronous machines, you can modify the default values as required. Setting range: 0–20000	1000	○
P03.10	ACR integral coefficient I		1000	○
P03.11	Torque setting mode	Used to enable the torque control mode and select the torque setting mode. 0: Torque control disabled 1: Keypad (P03.12) 2: Analog input AI1 3: Analog input AI2 4: Analog input AI3 5: Pulse frequency HDI 6–10: Reserved	0	○
P03.12	Torque set through keypad	Setting range: -300.0%→+300.0% (of the rated current of the motor)	10.0%	○
P03.16	Forward running frequency upper limit set through keypad in torque control	Setting range: 0.00 Hz–P00.03 (Max. output frequency)	100.00Hz	○

Function code	Name	Detailed description	Default value	Modify
P03.17	Reverse running frequency upper limit set through keypad in torque control		100.00 Hz	○
P03.20	Electromotion torque upper limit set through keypad	These two parameters are used to set the torque limits. Setting range: 0.0–300.0% (of the rated current of the motor)	180.0%	○
P03.21	Brake torque upper limit set through keypad		180.0%	○
P05 group Input terminals				
P05.01	S1 terminal function	0: No function 1: Forward running (FWD)	1	◎
P05.02	S2 terminal function	4: Forward jogging 6: Coast to stop 7: Fault reset	45	◎
P05.03	S3 terminal function	31: Reset the total cutting amount 32: Reset the cutting count value	31	◎
P05.04	S4 terminal function	43: Cutting reference point input (only valid for S6 to S8) 44: Immediate cutting command input terminal	32	◎
P05.05	S5 terminal function	45: Cutter reset to zero 46: Re-enable color code (If a color code error occurs in running, you can select a correct color code again. When this function is selected, the first color code must be correct.)	44	◎
P05.06	S6 terminal function	47: Color reference point input (valid only for S6 to S8 and HDI)	7	◎
P05.07	S7 terminal function	48: Enable the color code function (stop running when switching to this function) 49: Enable the rotary cutting function (stop running when switching to this function)	48	◎
P05.08	S8 terminal function	50: Paper-fed signal (S3–S7) (If the paper-fed signal is missed, the cutter stops at the 180° position.) 55: Cutting length selection (P23.24 is used as the cutting length when this function is valid, and P23.15 is used as the cutting length when this function is	43	◎
P05.09	HDI terminal function		47	◎

Function code	Name	Detailed description	Default value	Modify																				
		invalid.) 56: Emergency stop 57: Motor overtemperature fault input																						
P05.10	Input terminal polarity	Used to set the input terminal polarity. When the corresponding bit is set to 0, the polarity of the input terminal is positive. When the corresponding bit is set to 1, the polarity of the input terminal is negative. <table border="1" style="margin-left: 20px;"> <tr> <td></td> <td>BIT8</td> <td>BIT7</td> <td>BIT6</td> <td>BIT5</td> </tr> <tr> <td></td> <td>HDI</td> <td>S8</td> <td>S7</td> <td>S6</td> </tr> <tr> <td>BIT4</td> <td>BIT3</td> <td>BIT2</td> <td>BIT1</td> <td>BIT0</td> </tr> <tr> <td>S5</td> <td>S4</td> <td>S3</td> <td>S2</td> <td>S1</td> </tr> </table> Setting range: 0x000–0x1FF		BIT8	BIT7	BIT6	BIT5		HDI	S8	S7	S6	BIT4	BIT3	BIT2	BIT1	BIT0	S5	S4	S3	S2	S1	0x000	○
	BIT8	BIT7	BIT6	BIT5																				
	HDI	S8	S7	S6																				
BIT4	BIT3	BIT2	BIT1	BIT0																				
S5	S4	S3	S2	S1																				
P05.11	Digital filtering time	Set the sample filtering time of S1 to S8 and HDI. In scenarios where there is strong interference, you need to increase this parameter to prevent misoperation. Setting range: 0.000–1.000s	0.010s	○																				
P05.12	Virtual terminal setting	0x000–0x1FF (0: Disabled; 1: Enabled) BIT0: S1 virtual terminal BIT1: S2 virtual terminal BIT2: S3 virtual terminal BIT3: S4 virtual terminal BIT4: S5 virtual terminal BIT5: S6 virtual terminal BIT6: S7 virtual terminal BIT7: S8 virtual terminal BIT8: HDI virtual terminal	0x000	◎																				
P05.13	Running control mode of terminal	Used to set the running control mode of a terminal. 0: Two-wire control 1 The enabling and direction determination functions are integrated. This is the commonest two-wire mode, determining the forward and reverse running of the motor through the defined FWD and REV terminal commands.	0	◎																				

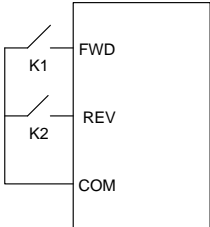
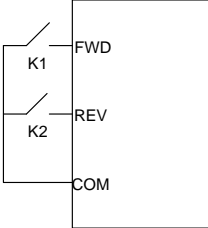
Function code	Name	Detailed description	Default value	Modify																														
		 <table border="1" data-bbox="655 183 837 411"> <thead> <tr> <th>FWD</th> <th>REV</th> <th>Running command</th> </tr> </thead> <tbody> <tr> <td>OFF</td> <td>OFF</td> <td>Stop</td> </tr> <tr> <td>ON</td> <td>OFF</td> <td>Forward running</td> </tr> <tr> <td>OFF</td> <td>ON</td> <td>Reverse running</td> </tr> <tr> <td>ON</td> <td>ON</td> <td>Holding on</td> </tr> </tbody> </table> <p>1: Two-wire control 2</p> <p>The enabling and direction determination functions are separated. In this mode, FWD is defined as the enabling terminal, and REV is defined as the direction determination terminal.</p>  <table border="1" data-bbox="632 582 819 810"> <thead> <tr> <th>FWD</th> <th>REV</th> <th>Running command</th> </tr> </thead> <tbody> <tr> <td>OFF</td> <td>OFF</td> <td>Stop</td> </tr> <tr> <td>ON</td> <td>OFF</td> <td>Forward running</td> </tr> <tr> <td>OFF</td> <td>ON</td> <td>Stop</td> </tr> <tr> <td>ON</td> <td>ON</td> <td>Reverse running</td> </tr> </tbody> </table>	FWD	REV	Running command	OFF	OFF	Stop	ON	OFF	Forward running	OFF	ON	Reverse running	ON	ON	Holding on	FWD	REV	Running command	OFF	OFF	Stop	ON	OFF	Forward running	OFF	ON	Stop	ON	ON	Reverse running		
FWD	REV	Running command																																
OFF	OFF	Stop																																
ON	OFF	Forward running																																
OFF	ON	Reverse running																																
ON	ON	Holding on																																
FWD	REV	Running command																																
OFF	OFF	Stop																																
ON	OFF	Forward running																																
OFF	ON	Stop																																
ON	ON	Reverse running																																
P05.32	Lower limit of AI1	<p>These function codes define the correspondence between the analog input voltage and the settings corresponding to the analog input. If an analog input voltage exceeds the set maximum value or is smaller than the set minimum value, the maximum or minimum value is used for calculation.</p> <p>When the analog input is current input, the current of 0 to 20 mA corresponds to the voltage of 0 to 10 V. The nominal value corresponding to the 100% of the analog setting varies according to application scenarios. For details, see the description of different application scenarios. The following figure shows several application scenarios.</p>	0.00 V	○																														
P05.33	Setting corresponding to lower limit of AI1		0.0%	○																														
P05.34	Upper limit of AI1		10.00 V	○																														
P05.35	Setting corresponding to upper limit of AI1		100.0%	○																														
P05.36	AI1 filtering time		0.030s	○																														
P05.37	Lower limit of AI2		0.00 V	○																														
P05.38	Setting corresponding to lower limit of AI2		0.0%	○																														
P05.39	Upper limit of AI2		10.00 V	○																														
P05.40	Setting corresponding to upper limit of AI2		100.0%	○																														
P05.41	AI2 filtering time		0.030s	○																														
P05.42	Lower limit of AI3	-10.00 V	○																															

Function code	Name	Detailed description	Default value	Modify
P05.43	Setting corresponding to lower limit of AI3		-100.0%	<input type="radio"/>
P05.44	Zero-drift value of AI3		0.00 V	<input type="radio"/>
P05.45	Zero dead-zone value of AI3		0.02 V	<input type="radio"/>
P05.46	Upper limit of AI3		10.00 V	<input type="radio"/>
P05.47	Setting corresponding to upper limit of AI3		100.0%	<input type="radio"/>
P05.48	AI3 filtering time	<p>Input filtering time: used to adjust the sensitivity of analog input. Increasing this value can enhance the anti-interference capability of the analog input but may also reduce the sensitivity of the analog input.</p> <p>Note: AI1 and AI2 can support the input of 0 to 10 V/0 to 20 mA. When AI1 and AI2 are 0 to 20 mA, the voltage corresponding to 20 mA is 10 V. AI3 supports the input of -10 to +10 V.</p> <p>Setting range of P05.32: 0.00V–P05.34 Setting range of P05.33: -300.0%–300.0% Setting range of P05.34: P05.32–10.00V Setting range of P05.35: -300.0%–300.0% Setting range of P05.36: 0.000s–10.000s Setting range of P05.37: 0.00V–P05.39 Setting range of P05.38: -300.0%–300.0% Setting range of P05.39: P05.37–10.00V Setting range of P05.40: -300.0%–300.0% Setting range of P05.41: 0.000s–10.000s Setting range of P05.42: -10.00V–P05.44 Setting range of P05.43: -300.0%–300.0% Setting range of P05.44: P05.42–P05.46 Setting range of P05.45: 0.00–10.00V Setting range of P05.46: P05.44–10.00V Setting range of P05.47: -300.0%–300.0% Setting range of P05.48: 0.000s–10.000s</p>	0.030s	<input type="radio"/>
P05.50	Lower limit of HDI frequency	0.000 kHz–P05.52	10.000 kHz	<input type="radio"/>

Function code	Name	Detailed description	Default value	Modify
P05.51	Setting corresponding to lower limit of HDI frequency	-300.0%~300.0%	-200.0%	○
P05.52	Upper limit of HDI frequency	P05.50~50.000 kHz	50.000 kHz	○
P05.53	Setting corresponding to upper limit of HDI frequency	-300.0%~300.0%	200.0%	○
P05.54	HDI frequency input filtering time	0.000s~10.000s	0.000s	○
P06 group Output terminals				
P06.00	HDO output type	Used to set the function of a high-speed pulse output terminal. 0: Open collector high-speed pulse output with a maximum pulse frequency of 50.0 kHz. For related functions, see the description of P06.27 to P06.31. 1: Open collector output. For the related function, see the description of P06.02.	0	◎
P06.01	Y output	0: Invalid	0	○
P06.02	HDO output	1: In running	0	○
P06.03	Relay output RO1	5: Servo drive fault 26: DC bus voltage established 27: Cutting point output (20 ms)	0	○
P06.04	Relay output RO2	28: Output of alarms generated when the set cutting amount is reached 30: Output of alarms generated when color codes are missed 32: Cutter reference point detection completed 33: Output of alarms generated when the set cutting amount is reached in a batch (refer to the description of P21.24 and P21.25)	0	○
P06.05	Polarity of output terminal	Used to set the polarities of output terminals. When the corresponding bit is set to 0, the polarity of the output terminal is positive. When the corresponding bit is set to 1, the polarity of	0x0	○

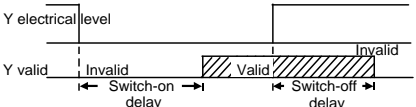
Function code	Name	Detailed description	Default value	Modify								
		the output terminal is negative. <table border="1" style="margin-left: auto; margin-right: auto;"> <tr> <td>BIT3</td> <td>BIT2</td> <td>BIT1</td> <td>BIT0</td> </tr> <tr> <td>RO2</td> <td>RO1</td> <td>HDO</td> <td>Y</td> </tr> </table> Setting range: 0x0–0xF	BIT3	BIT2	BIT1	BIT0	RO2	RO1	HDO	Y		
BIT3	BIT2	BIT1	BIT0									
RO2	RO1	HDO	Y									
P06.06	Y switch-on delay time	Used to define the delay time of electrical level change when a programmable output terminal is switched on or off. 	0.000s	○								
P06.07	Y switch-off delay time		0.000s	○								
P06.08	HDO switch-on delay time		0.000s	○								
P06.09	HDO switch-off delay time		0.000s	○								
P06.10	RO1 switch-on delay time		Setting range: 0.000–50.000s	0.000s	○							
P06.11	RO1 switch-off delay time		Note:	0.000s	○							
P06.12	RO2 switch-on delay time		P06.08 and P06.09 are valid only when P06.00 is set to 1.	0.000s	○							
P06.13	RO2 switch-off delay time			0.000s	○							
P06.16	HDO high-speed pulse output		0: Running frequency 22: Torque current (corresponding to the rated current of the motor) 25: Ramp frequency reference (dual-polarity)	0	○							
P06.27	Lower limit of HDO output			-200.0%	○							
P06.28	Setting corresponding to lower limit of HDO output		Setting range of P06.27: -300.0%–P06.29	10.00 kHz	○							
P06.29	Upper limit of HDO output		Setting range of P06.28: 0.00–50.00kHz	200.0%	○							
P06.30	Setting corresponding to upper limit of HDO output		Setting range of P06.29: P06.27–300.0%	50.00 kHz	○							
P06.31	HDO filtering time	Setting range of P06.30: 0.00–50.00kHz Setting range of P06.31: 0.000–10.000s	0.000s	○								

Function code	Name	Detailed description	Default value	Modify
P07 group Human-machine interface (HMI)				
P07.00	User password	<p>0-65535</p> <p>If you set this parameter to a non-zero value, the password protection function is enabled.</p> <p>If you set this parameter to 00000, the user password set before is deleted, and the password protection function is disabled.</p> <p>After a user password is set and takes effect, you need to enter the correct password to enter the parameter menus before you can view or modify parameters. Remember the user password you set.</p> <p>The password protection takes effect one minute after you exit from the function code editing interface. After the password protection takes effect, "0.0.0.0.0" is displayed when you press the PRG/ESC key to enter the function code editing interface. You need to enter the correct password to enter the interface.</p> <p>Note: Restoring the default values may delete user passwords. Use this function with caution.</p>	0	○
P07.01	Function parameter copy	<p>Used to set the parameter copying mode.</p> <p>0: No operation</p> <p>1: Upload function parameters from the machine to keypad</p> <p>2: Download function parameters (including the motor parameters) from the keypad to machine</p> <p>3: Download function parameters (excluding motor parameters of the P02 and P12 groups) from the keypad to machine</p> <p>4: Download function parameters (only motor parameters of the P02 and P12 groups) from the keypad to machine</p> <p>Note: After the parameter is set to 1, 2, 3 or 4, and the operation is executed, the parameter is automatically restored to 0. The parameters uploaded or downloaded do not include those of the P29 group (factory function parameters).</p>	0	◎

Function code	Name	Detailed description	Default value	Modify
P07.05	Selection 1 of parameters to be displayed in the running state	0x0000–0xFFFF BIT0: Running frequency (Hz on) BIT1: Set frequency (Hz blinks) BIT2: Bus voltage (V on) BIT3: Output voltage (V on) BIT4: Output current (A) BIT5: Rotating speed (rpm on) BIT6: Output power (% on) BIT7: Output torque (% on) BIT8– BIT9: Reserved BIT10: Input terminal state BIT11: Output terminal state BIT12: Set torque (% on) BIT13– BIT15: Reserved	0x03FF	○
P07.06	Selection 2 of parameters to be displayed in the running state	0x0000–0xFFFF BIT0: AI1 (V on) BIT1: AI2 (V on) BIT2: AI3 (V on) BIT3: High-speed pulse HDI frequency BIT4: Motor overload percentage (% on) BIT5: Servo drive overload percentage (% on) BIT6: Ramp frequency reference (Hz on) BIT7–15: Reserved	0x0000	○
P07.07	Selection of parameters to be displayed in the stop state	0x0000–0xFFFF BIT0: Set frequency (Hz on, frequency blinks slowly) BIT1: Bus voltage (V on) BIT2: Input terminal state BIT3: Output terminal state BIT4– BIT5: Reserved BIT6: Set torque (% on) BIT7: AI1 (V on) BIT8: AI2 (V on) BIT9: AI3 (V on) BIT10–BIT15: Reserved	0x00FF	○
P07.11	Temperature of bridge rectifier module	-20.0–120.0°C		●
P07.12	Temperature of the inverter	-20.0–120.0°C		●

Function code	Name	Detailed description	Default value	Modify
	module			
P07.13	Control board software version	1.00–655.35		●
P07.14	Accumulated running time	0–65535h		●
P07.15	Most significant digit of power consumption of servo drive	Displayed power consumption of the servo drive Power consumption of the servo drive = P07.15×1000+P07.16		●
P07.16	Least significant digit of power consumption of servo drive	Setting range of P07.15: 0–65535 kWh (×1000) Setting range of P07.16: 0.0–999.9 kWh		●
P07.18	Rated power of servo drive	0.4–3000.0 kW		●
P07.19	Rated voltage of servo drive	50–1200 V		●
P07.20	Rated current of servo drive	0.1–6000.0 A		●
P07.21	Factory bar code 1	0x0000–0xFFFF		●
P07.22	Factory bar code 2	0x0000–0xFFFF		●
P07.23	Factory bar code 3	0x0000–0xFFFF		●
P07.24	Factory bar code 4	0x0000–0xFFFF		●
P07.25	Factory bar code 5	0x0000–0xFFFF		●
P07.26	Factory bar code 6	0x0000–0xFFFF		●
P07.27	Type of current fault	0: No fault 1: Inverter unit U phase protection (OUt1)		●
P07.28	Type of last fault	2: Inverter unit V phase protection (OUt2)		●
P07.29	Type of last but	3: Inverter unit W phase protection (OUt3)		●

Function code	Name	Detailed description	Default value	Modify
	one fault	4: ACC overcurrent (OC1)		
P07.30	Type of last but two fault	5: DEC overcurrent (OC2) 6: Constant-speed overcurrent (OC3)		●
P07.31	Type of last but three fault	7: ACC overvoltage (OV1) 8: DEC overvoltage (OV2)		●
P07.32	Type of last but four fault	9: Constant-speed overvoltage (OV3) 10: Bus undervoltage fault (UV) 11: Motor overload (OL1) 12: Servo drive overload (OL2) 13: Phase loss on the input side (SPI) 14: Phase loss on the output side (SPO) 15: Rectifier module overheat (OH1) 16: Inverter module overheat (OH2) 17: External fault (EF) 18: 485 communication fault (CE) 19: Current detection fault (ItE) 20: Motor autotuning fault (tE) 21: EEPROM operation fault (EEP) 22: PID feedback disconnection fault (PIDE) 23: Brake unit fault (bCE) 24: Running time ends (END) 25: Electronic overload (OL3) 26: Panel communication error (PCE) 27: Parameter upload error (UPE) 28: Parameter download error (DNE) 29: PROFIBUS communication fault (E-DP) 30: Ethernet communication fault (E-NET) 31: CANopen communication fault (E-CAN) 32: Short-to-ground fault 1 (ETH1) 33: Short-to-ground fault 2 (ETH2) 34: Speed deviation fault (dEu) 35: Misadjustment fault (STo) 36: Underload fault (LL) 37: Encoder disconnection fault (ENC1O) 38: Encoder reverse running fault (ENC1D) 39: Encoder Z pulse disconnection fault (ENC1Z) 43: Motor overtemperature fault (OT) 44: Fault specific to flying shears (ECUT1-ECUT7)		●
P07.33	Running		0.00 Hz	●

Function code	Name	Detailed description	Default value	Modify
	frequency at current fault			
P07.34	Ramp frequency reference at current fault		0.00 Hz	●
P07.35	Output voltage at current fault		0 V	●
P07.36	Output current at current fault		0.0 A	●
P07.37	Bus voltage at current fault		0.0 V	●
P07.38	Highest temperature at current fault		0.0°C	●
P07.39	Input terminal state at current fault		0	●
P07.40	Output terminal state at current fault		0	●
P07.41	Running frequency at last fault		0.00 Hz	●
P07.42	Ramp frequency reference at last fault		0.00 Hz	●
P07.43	Output voltage at last fault		0 V	●
P07.44	Output current at last fault		0.0 A	●
P07.45	Bus voltage at last fault		0.0 V	●
P07.46	Highest temperature at last fault		0.0°C	●
P07.47	Input terminal state at last fault		0	●
P07.48	Output terminal		0	●

Function code	Name	Detailed description	Default value	Modify
	state at last fault			
P07.49	Running frequency at last but one fault		0.00 Hz	●
P07.50	Ramp frequency reference at last but one fault		0.00 Hz	●
P07.51	Output voltage at last but one fault		0V	●
P07.52	Output current at last but one fault		0.0 A	●
P07.53	Bus voltage at last but one fault		0.0 V	●
P07.54	Highest temperature at last but one fault		0.0°C	●
P07.55	Input terminal state at last but one fault		0	●
P07.56	Output terminal state at last but one fault		0	●
P08 group Enhanced functions				
P08.06	Jogging frequency	Used to set the frequency reference of the servo drive for jogging operation. Setting range: 0.00Hz–P00.03 (Max. output frequency)	5.00 Hz	○
P08.07	Jogging ACC time	Time the servo drive takes to accelerate from 0 Hz to P00.03 (Max. output frequency) Setting range: 0.0–3600.0s	Depend on model	○
P08.08	Jogging DEC time	Time the servo drive takes to decelerate from P00.03 (Max. output frequency) to 0 Hz. Setting range: 0.0–3600.0s	Depend on model	○
P08.22	Torque for inertia identification	0.0–100.0% (of the rated torque of the motor) Note: If the torque is too large, the inertia autotuning speed may be too fast; and if the torque is too small, the inertial autotuning may fail.	10.0%	○
P08.23	Inertia	0: No operation	0	◎

Function code	Name	Detailed description	Default value	Modify
	autotuning	1: Autotuning enabled Note: After this parameter is set to 1, the motor accelerates and decelerated repeatedly to perform inertial autotuning. The maximum speed is 3/4 of the rated speed. After the autotuning is complete, the keypad displays "-END-", and the autotuning result is stored in P21.28.		
P11 group Protection parameters				
P11.00	Phase loss protection	0x00–0x11 LED ones place (reserved): 0: Input phase loss protection disabled 1: Input phase loss protection enabled LED tens place: 0: Output phase loss protection disabled 1: Output phase loss protection enabled LED hundreds place: 0: Input phase loss protection disabled 1: Input phase loss protection enabled	0x110	○
P11.06	Max. output current	Setting range: 50.0–200.0% (of the rated current of the servo drive)	160.0%	◎
P11.13	Fault output terminal action at fault	Used to set the action of the fault output terminal during undervoltage and auto fault reset 0x00–0x11 LED ones place: 0: Perform an action at undervoltage fault 1: No action at undervoltage fault LED tens place: 0: Perform an action during auto reset 1: No action during auto reset	0x00	○
P11.14	Speed deviation detection value	Used to set the speed deviation detection value. 0.0–50.0%	10.0%	○
P11.15	Speed deviation detection time	Used to set the time for detecting speed deviation. Note: No speed deviation protection is performed when P11.15 is set to 0.0.	1.0s	○

Function code	Name	Detailed description	Default value	Modify
		<p>Setting range: 0.0–10.0s</p>		
P13 group Synchronous motor control parameters				
P13.01	Initial magnetic pole detection mode	<p>If you use an ABZ encoder to drive a synchronous motor, angle autotuning needs to be performed at the first time of power-on.</p> <p>0: Pulse superposition 1: Reserved 2: DC brake</p>	0	⊙
P13.06	Pulse superposition voltage	0.0–300.0% (of the rated voltage of the motor)	100.0%	⊙
P14 group Serial communication functions				
P14.00	Communication address	<p>Setting range: 1–247</p> <p>When the master is writing a frame in which the slave communication address is set to 0, that is, a broadcast address, all the slaves on the Modbus receive the frame but do not respond to it.</p> <p>The communication addresses on the communication network are unique, which is the basis of the point-to-point communication between the upper computer and servo drive.</p> <p>Note: The communication address of a slave cannot be set to 0.</p>	1	○
P14.01	Communication baud rate	<p>Used to set the rate of data transmission between the upper computer and servo drive.</p> <p>0: 1200BPS 1: 2400BPS 2: 4800BPS 3: 9600BPS</p>	4	○

Function code	Name	Detailed description	Default value	Modify
		4: 19200BPS 5: 38400BPS 6: 57600BPS 7: 115200BPS Note: The baud rate set on the servo drive must be consistent with that on the upper computer. Otherwise, the communication fails. The greater the baud rate, the faster the communication.		
P14.02	Data bit check	The data format set on the servo drive must be consistent with that on the upper computer. Otherwise, the communication fails. 0: No check (N, 8, 1) for RTU 1: Even check (E, 8, 1) for RTU 2: Odd check (O, 8, 1) for RTU 3: No check (N, 8, 2) for RTU 4: Even check (E, 8, 2) for RTU 5: Odd check (O, 8, 2) for RTU	1	○
P14.03	Communication response delay	0–200 ms Indicates the period from the time the servo drive completes the receiving of data to the time it transmits response data to the upper computer. If the response delay set is shorter than the system processing time, the servo drive transmits the response data to the upper computer after the data is processed by the system; if the delay set is longer than the system processing time, the servo drive waits, after the data is processed by the system, until the delay time ends, and then transmits data to the upper computer.	5ms	○
P14.04	Communication timeout time	0.0 (invalid); 0.1–60.0s When this parameter is set to 0.0, the communication timeout time is invalid. When this parameter is set a non-zero value, the system reports the "485 communication fault" (CE) if the communication interval exceeds the value of this parameter. In general, this parameter is set to 0.0. In systems where continuous communication is performed, you	0.0s	○

Function code	Name	Detailed description	Default value	Modify
		can set this parameter to monitor the communication state.		
P14.05	Transmission error handling	0: Generate an alarm and coast to stop 1: No alarm and continue to run 2: No alarm and stop according to the stop mode (only in the communication-based control mode) 3: No alarm and stop according to the stop mode (in all control modes)	0	○
P14.06	Communication handling action	0x000–0x111 LED ones place: 0: Responding to write operations. The servo drive responds to read and write commands of the upper computer. 1: No response to write operations. The servo drive does not respond to the write commands, but responds only to the read commands of the upper computer. Setting the parameter to this value can improve the communication efficiency. LED tens place: 0: Communication encryption is invalid. 1: Communication encryption is valid. LED hundreds place: 0: Function parameters modified through communication are stored during PoFF. 1: Function parameters modified are stored based on the most significant bit (MSB) of the communication address. If the MSB is 1, they are stored during PoFF; and if it is 0, they are stored immediately.	0x000	○
P17 group State viewing 1				
P17.00	Set frequency	Displays the current set frequency for the servo drive. Range: 0.00 Hz–P00.03	0.00 Hz	●
P17.01	Output frequency	Displays the current output frequency of the servo drive. Range: 0.00 Hz–P00.03	0.00 Hz	●
P17.02	Ramp frequency reference	Displays the current ramp frequency reference of the servo drive. Range: 0.00 Hz–P00.03	0.00 Hz	●

Function code	Name	Detailed description	Default value	Modify																				
P17.03	Output voltage	Displays the current output voltage of the servo drive. Range: 0–1200V	0 V	●																				
P17.04	Output current	Displays the current output current of the servo drive. Range: 0.0–5000.0 A	0.0 A	●																				
P17.05	Motor rotating speed	Displays the current rotating speed of the motor. Range: 0–65535 RPM	0 RPM	●																				
P17.06	Torque current	Displays the current torque current of the servo drive. Range: -3000.0–3000.0 A	0.0 A	●																				
P17.07	Exciting current	Displays the current exciting current of the servo drive. Range: -3000.0–3000.0 A	0.0 A	●																				
P17.08	Motor power	Displays the current power of the motor. 100.0% corresponds to the rated power of the motor. A positive value indicates that the motor is in the electromotion state, and a negative value indicates that it is in the power generation state. Range: -300.0–+300.0% (of the rated power of the motor)	0.0%	●																				
P17.09	Output torque	Displays the current output torque of the servo drive. 100.0% corresponds to the rated torque of the motor. In forward running, a positive value indicates that the motor is in the electromotion state, and a negative value indicates that it is in the power generation state. In reverse running, a positive value indicates that the motor is in the power generation state, and a negative value indicates that it is in the electromotion state. Range: -250.0–+250.0%	0.0%	●																				
P17.11	DC bus voltage	Displays the current DC bus voltage of the servo drive. Range: 0.0–2000.0 V	0.0 V	●																				
P17.12	Digital input terminal state	Displays the current digital input terminal state of the servo drive. <table border="1" style="margin-left: auto; margin-right: auto;"> <tr> <td></td> <td>BIT8</td> <td>BIT7</td> <td>BIT6</td> <td>BIT5</td> </tr> <tr> <td></td> <td>HDI</td> <td>S8</td> <td>S7</td> <td>S6</td> </tr> <tr> <td></td> <td>BIT4</td> <td>BIT3</td> <td>BIT2</td> <td>BIT1</td> </tr> <tr> <td></td> <td></td> <td></td> <td></td> <td>BIT0</td> </tr> </table>		BIT8	BIT7	BIT6	BIT5		HDI	S8	S7	S6		BIT4	BIT3	BIT2	BIT1					BIT0	0	●
	BIT8	BIT7	BIT6	BIT5																				
	HDI	S8	S7	S6																				
	BIT4	BIT3	BIT2	BIT1																				
				BIT0																				

Function code	Name	Detailed description	Default value	Modify								
		<table border="1"> <tr> <td>S5</td> <td>S4</td> <td>S3</td> <td>S2</td> <td>S1</td> </tr> </table> Range: 0000–01FF	S5	S4	S3	S2	S1					
S5	S4	S3	S2	S1								
P17.13	Digital output terminal state	Displays the current digital output terminal state of the servo drive. <table border="1"> <tr> <td>BIT3</td> <td>BIT2</td> <td>BIT1</td> <td>BIT0</td> </tr> <tr> <td>RO2</td> <td>RO1</td> <td>HDO</td> <td>Y</td> </tr> </table> Range: 0000–000F	BIT3	BIT2	BIT1	BIT0	RO2	RO1	HDO	Y	0	●
BIT3	BIT2	BIT1	BIT0									
RO2	RO1	HDO	Y									
P17.15	Torque reference	Displays the torque reference, a percentage relative to the rated torque of the motor. Range: -300.0%–+300.0% (of the rated current of the motor)	0.0%	●								
P17.16	AI1 adjustment voltage	Displays the adjustment voltage of AI1. 0.00–10.00 V	0.00 V	●								
P17.17	AI2 adjustment voltage	Displays the adjustment voltage of AI2. 0.00–10.00 V	0.00 V	●								
P17.18	AI3 adjustment voltage	Displays the adjustment voltage of AI3. 0.00–10.00 V	0.00 V	●								
P17.19	AI1 input voltage	Displays the input signal of AI1. Range: 0.00–10.00 V	0.00 V	●								
P17.20	AI2 input voltage	Displays the input signal of AI2. Range: 0.00–10.00 V	0.00 V	●								
P17.21	AI3 input voltage	Displays the input signal of AI3. Range: -10.00–+10.00 V	0.00V	●								
P17.22	HDI input frequency	Displays the HDI input frequency. Range: 0.000–50.000 kHz	0.000 kHz	●								
P17.23	Detected color code deviation	Range: -10.000–+10.000 mm Note: It is the deviation relative to P23.15 (Cutting length) or the internal correction value.	0.000mm	●								
P17.24	Number of consecutive missed color codes	Range: 0–65535	0	●								
P17.28	Detected color code correction length	Range: 0.0–6000.0mm	0.0 mm	●								
P17.31	Position deviation in the	-32767–+32767 Short-board cutting: A positive value indicates that	0	●								

Function code	Name	Detailed description	Default value	Modify
	synchronization area	the cutter lags, that is, overcompensation for P21.28 (Torque feedforward gain); and a negative value indicates that the cutter overshoots, that is, undercompensation for P21.28. Long-board cutting: A positive value indicates that the cutter lags, that is, undercompensation for P21.28 (Torque feedforward gain); and a negative value indicates that the cutter overshoots, that is, overcompensation for P21.28.		
P17.32	Cutting point pulse deviation	Range: -32767—+32767	0	●
P17.33	Exciting current reference	Displays the exciting current reference in the vector control mode. Range: -3000.0—+3000.0 A	0.0 A	●
P17.34	Torque current reference	Displays the torque current reference in the vector control mode. Range: -3000.0—+3000.0 A	0.0 A	●
P17.35	UVW encoder state	Range: 0–7	0	●
P17.37	Torque feedforward percentage	Range: -300.0%—+300.0%	0.0%	●
P17.38	Torque percentage reference	Range: -300.0%—+300.0%	0.0%	●
P17.39	Parameter download error function code	Range: 0.00–29.00	0.00	●
P18 group State viewing 2				
P18.00	Detected encoder frequency	Detected encoder frequency. A positive value indicates that the motor is running forward, and a negative value indicates that the motor is running reversely. Range: -3276.8—+3276.7 Hz	0.0 Hz	●
P18.01	Encoder position count value	Encoder count value, quadruplicated frequency. Range: 0–65535	0	●
P18.02	Encoder Z pulse position value	Count value corresponding to the encoder Z pulse Range: 0–65535	0	●

Function code	Name	Detailed description	Default value	Modify
P18.03	Max. value of the UVW encoder state	Range: 0–7	0	●
P18.04	Min. value of the UVW encoder state	Range: 0–7	0	●
P18.05	Cutting amount in the current batch	0–60000 Note: Refer to P21.24 and P21.25.	0	●
P18.06	Color code width	0–6553.5mm Note: It is the actual color code width detected.	0	●
P18.07	Position deviation	Pulse deviation between the current position reference and the actual running position. Range: -32768→+32767	0	●
P18.09	Cutter perimeter	0–6553.5 mm Note: The cutter perimeter is calculated based on the diameter of the cutter.	0.0 mm	●
P18.10– P18.11	Actual number of cutter motor pulses per revolution (detected by a sensor)	0–65535000 Note: Number of pulses per revolution of the cutter = $P20.01 \times 4 \times P23.04 / P23.05$; P18.10 is the most significant digit (MSD), and P18.11 is the least significant digit (LSD).	0	●
P18.12	Set length for the current cutting	0–65535	0	●
P18.13	Number of Z pulse errors	Range: 0–65535	0	●
P18.14	MSD of Pg1 pulse count	Encoder pulse count value. The counting continues once the servo drive is powered on. Range: 0–65535	0	●
P18.15	LSD of Pg1 pulse count	Encoder pulse count value. The counting continues once the servo drive is powered on. Range: 0–65535	0	●
P18.16	Cutting fault code	0–9	0	●
P18.17	Total cutting	0–65535	0	●

Function code	Name	Detailed description	Default value	Modify
	amount (MSD)			
P18.18	Total cutting amount (LSD)	0–65535	0	●
P18.19	Position regulator output	Output frequency of the position regulator during position control. Range: 0.00–400.00 Hz	0.00 Hz	●
P18.20	Actual cutting length	0–6553.5 mm	0.0 mm	●
P18.22	Magnetic pole angle	Current magnetic pole position. Range: 0.00–359.99	0.00	●
P18.24	Number of material feeding pulses (MSD)	0–65535	0	●
P18.25	Number of material feeding pulses (LSD)	0–65535	0	●
P18.26	Cutting error (detected by sensor)	-32.000+32.000 mm Including cutting error and detected optoelectronic switch error	0.000 mm	●
P18.27	Cutting error (detected by software)	-32.000+32.000 mm	0.000 mm	●
P18.28	Detected pulse deviation at the proximity switch	-1000+1000 Note: If the value of this parameter is greater than P23.21, ECUT6 (rotary cutter sensor detection error) is reported. The value cannot be accumulated. Otherwise, the rotary cutter deceleration ratio (P23.04/P23.05) is set incorrectly. You can also prevent deviation accumulation by increasing P23.20. Moreover, the smaller fluctuation of the value, the better.	0	●
P18.29	Cutting amount	0–65535 The value of this parameter is automatically reset to 0 after P23.15 (cutting length) is modified.	0	●
P18.30	Cutter position	0.0°–359.9° (referring to the cutting point as 0°)	0.0	●
P18.31	Material feeding linear speed	-600.0+600.0 m/min	0.0 m/min	●

Function code	Name	Detailed description	Default value	Modify
	(detected value)			
P18.32	Cutter linear speed (detected value)	-600.0—+600.0 m/min	0.0 m/min	●
P20 group Encoder				
P20.00	Encoder type	0: Incremental encoder 1: ABZ UVW encoder 2: Resolver encoder 3: Sin/cos encoder without CD signals 4: Sin/cos encoder with CD signals	0	◎
P20.01	Number of encoder pulses	Number of pulses the encoder generates after rotating one circle. Setting range: 0–60000	1024	◎
P20.02	Encoder direction	Ones place: AB direction 0: Forward; 1: Reverse Tens place: Z pulse direction 0: Forward; 1: Reverse Hundreds place: Magnetic pole detection signal direction 0: Forward; 1: Reverse	0x000	◎
P20.03	Encoder disconnection fault detection time	Time for detecting encoder disconnection faults. Setting range: 0.0–100.0s	1.0s	○
P20.04	Encoder reversing running fault detection time	Time for detecting encoder reverse running faults. Setting range: 0.0–100.0s	0.8s	○
P20.05	Number of encoder detection filtering times	Setting range: 0x00–0x99 Ones place: Number of low-speed filtering times; corresponding to $2^{(0-9)} \times 125 \mu\text{s}$ Tens place: Number of high-speed filtering times; corresponding to $2^{(0-9)} \times 125 \mu\text{s}$	0x33	○
P20.07	Synchronous machine control parameter	Setting range: 0x0000–0xFFFF Generally, you do not need to modify this parameter. Bit0: Z pulse correction enabling Bit1: Encoder angle correction enabling	0x0003	○
P20.09	Initial angle of Z	Electrical degree between the Z pulse of the encoder	0.00	○

Function code	Name	Detailed description	Default value	Modify
	pulse	and the magnetic pole position of the motor. Setting range: 0.00–359.99		
P20.10	Initial magnetic pole angle	Electrical degree between the position of the encoder and the magnetic pole position of the motor. Setting range: 0.00–359.99	0.00	○
P20.11	Initial magnetic pole angle autotuning	Setting range: 0–3 0: No operation 1: Rotating autotuning (without load) 2: Static autotuning (applicable to resolvers and sin/cos encoders) 3: Rotating autotuning (with load) After you set this parameter to 1 or 2 and confirm the setting, the keypad displays "-RUN-". Press the "RUN" key, and the autotuning of the initial magnetic pole angle is performed. The autotuning ends when the keypad displays "-END-", and the identified initial magnetic pole angle is stored in P20.09 and P20.10. The initial magnetic pole angle obtained through autotuning of 1 (Rotating autotuning) is more accurate, so this parameter is commonly set to 1. In such cases, you need to disconnect the load from the motor, or ensure that the load of the motor is light.	0	◎
P20.12	Encoder detection filtering time	0–200.0 μ s Note: To prevent encoder interference, you need to set the encoder signal filtering width properly. Generally, the filtering width cannot exceed half of the minimum width of the encoder. For example, if the maximum pulse frequency of the encoder is 100 kHz, its minimum width is 5 μ s (calculated based on the duty ratio of 50%), and so the value of this parameter needs to be less than 2.5 μ s.	3.0 μ s	○
P20.13	Speed measuring method	0: Common mode 1: Optimized mode	0	◎
P21 group Position control and flying shear parameters				
P21.01	Material feeding pulse command	LED ones place: Pulse mode 0: A / B orthogonal pulse; A leads B	0x0000	◎

Function code	Name	Detailed description	Default value	Modify
	mode	1: A: Clock; B: Direction 2: A: Count in ascending order 3: A: Count in descending order LED tens place: Pulse direction Bit0: Pulse forward direction setting 0: Forward 1: Reverse		
P21.02	APR reset-to-zero gain	Setting range: 0.0–400.0	20.0	○
P21.03	APR cutting gain	Setting range: 0.0–400.0 Note: Increasing the value of this parameter can improve the cutting accuracy. Try to increase the value while ensuring that the motor does not oscillate.	60.0	○
P21.08	APR output amplitude limit	Setting range: 0.0–100.0% of P00.03 (Max. output frequency)	5.0%	○
P21.11	Numerator of the material feeding pulse gear ratio	Setting range: 1–1000	100	○
P21.12	Denominator of the material feeding pulse gear ratio	Setting range: 1–1000 Note: Number of pulses generated when the material feeding roller rotates one circle = $P23.07 \times 4 \times P21.11 / P21.12$	100	○
P21.20	ACC time of cutting proximity switch searching	Setting range of P21.20: 0.01–300.00s	3.00s	○
P21.21	DEC time of cutting proximity switch searching	Setting range of P21.21: 0.01–300.00s	3.00s	○
P21.23	Speed of proximity switch searching	Setting range: 0.00–50.00 Hz	2.00 Hz	○
P21.24	Single-batch cutting amount setting for alarm generation	Setting range: 0–60000	50	○

Function code	Name	Detailed description	Default value	Modify
P21.25	Single-batch cutting amount setting for advanced alarm generation	Setting range: 0–600 For example, if P21.24 is set to 50, and this parameter is set to 3, an alarm is generated when the cutting amount in a batch is 47 (P21.24- P21.25).	3	○
P21.27	Min. material feeding linear speed	Setting range: 0.0–5.0 m/min	0.2 m/min	○
P21.28	Torque feedforward gain	Setting range: 0%–300.0% 1. P21.28 × Rated torque of the motor, allowing the motor to accelerate from 0 to P00.03 (Max. output frequency) in 1s. 2. Set this parameter to 0 for low-speed cutting. 3. The value of this parameter can be obtained through inertial autotuning parameters. Refer to P08.22 and P08.23.	0.0%	○
P21.29	Material feeding speed filtering time	Setting range: 0–3200.0 ms Note: If the acceleration or deceleration of the material feeding speed is fast, you need to set this parameter to a short time. Otherwise, the cutting deviation increases during the acceleration or deceleration.	10.0 ms	○
P21.30	High-speed analog	Setting range: 0–0x21 Ones place: Enabling option 0: Terminal enabling (terminal function #58) 1: Enabling (internal enabling) Tens place: Analog port option 0: AI3 1: AI1 2: AI2	0x00	◎
P21.31	High-speed analog filtering time	Setting range: 0.1–10.0 ms	1.0 ms	○
P21.33	Reset-to-zero signal type	Setting range: 0–1 0: Electrical level signal 1: Pulse signal	0	○
P21.34	Material feeding encoder detection filtering	Setting range: 0–20.0 μs Note: To prevent encoder interference, you need to set the	3.0 μs	○

Function code	Name	Detailed description	Default value	Modify
	time	encoder signal filtering width properly. Generally, the filtering width cannot exceed half of the minimum width of the encoder. For example, if the maximum pulse frequency of the encoder is 50 kHz, its minimum width is 10 μ s (calculated based on the duty ratio of 50%), and so the value of this parameter needs to be less than 5.0 μ s.		
P22 group Color code and cutting				
P22.00	Color code cutting selection	Setting range: 0–0x111 Ones place: Color code enabling option 0: Disabled 1: Enabled Tens place: Color code installation distance setting Bit0: P22.01 direction setting 0: Set P22.01 to forward 1: Set P22.01 to reverse Bit1: P22.01 magnification option 0: \times 1 1: \times 10 (for example, if P22.01 is 1000.0 mm, the actual installation distance is 10000 mm) Hundreds place: Color code detection filtering compensation 0: Compensated 1: No compensation	0	<input type="radio"/>
P22.01	Color code sensor installation distance	Setting range: 0.0–6500.0 mm Note: 1. Distance between the color code detection point and the cutting point of the rotary cutter. If the cutting point is behind the color code, you need to reduce the value; and if the cutting point is before the color code, you need to increase the value. 2. The color code sensor can be installed at any position. You just need to set the installation distance properly.	1000.0 mm	<input type="radio"/>
P22.02	Color code sensor offset	Setting range: -999.9–2000.0 mm Note: Used to set the offset distance between the cutting position of the fed material and the color code. A negative value indicates that the cutting position is	0.0mm	<input type="radio"/>

Function code	Name	Detailed description	Default value	Modify
		before the color code.		
P22.03	Color code signal detection window	Setting range: 0–3000.0mm Note: If a color code appears within the window scope of P23.15 (Cutting length), it is identified as a correct color code. Otherwise, it is identified as a wrong color code and discarded.	50.0mm	○
P22.04	Number of color codes in each cutting	Setting range: 1–100 Note: Used to set the number of color codes included in one cutting length (P23.15).	1	○
P22.05	Number of auto corrections of the color code cutting length	Setting range: 0–100 Note: If it is continuously detected that the color code distance exceeds P22.06, the cutting length is automatically corrected. The cutting length is not corrected if this parameter is set to 0.	10	○
P22.06	Deviation threshold for auto color code correction	Setting range: 0.0–1000.0 mm Note: Used in combination with P22.05 to automatically correct the cutting length.	1.0 mm	○
P22.07	Number of color code sensor detection filtering times	Setting range: 0–80 (×125 μs)	0	○
P22.08	First color code alignment window	Setting range: 0–1000.0 mm (0: Disabled)	0.0 mm	○
P22.09	Max. length of first color code alignment	Setting range: 0–1000.0mm (0: 20.0 mm) (This parameter is invalid if P22.08 is set to 0.)	0.0 mm	○
P22.10	Threshold for number of consecutive missed color codes	Setting range: 0–1000	4	○
P22.11	Action at color code missing	Setting range: 0–3 When the number of color code missing times is greater than P22.10:	0	○

Function code	Name	Detailed description	Default value	Modify
		0: Auto color code re-alignment; output only alarm signals (#30) but no fault signals. 1: No color code re-alignment; continue the cutting based on the set length; output only alarm signals (#30) but no fault signals. 2: No color code re-alignment; continue the cutting based on the set length; output both fault signals and alarm signals (#30). 3: No color code re-alignment; return to the zero point and then stop and report fault; output both fault signals and alarm signals (#30).		
P22.12	Color code sensor detection delay	0.00–30.00 ms Note: Used to set the response delay of the color code sensor for compensating the actual position detected by the color code sensor.	0.05 ms	<input type="radio"/>
P22.13	Cutting amount	0: Disabled 1–65535	0	<input type="radio"/>
P22.14	Cutting amount setting for alarm generation	0–65535	0	<input type="radio"/>
P22.15	Alarm signal output selection	0: Buzzer 1: Alarm indicator	0	<input type="radio"/>
P22.16	High electrical level time of alarm signal output	0–60.000s	1.000s	<input type="radio"/>
P22.17	Low electrical level time of alarm signal output	0–60.000s	1.000s	<input type="radio"/>
P23 group Cutting functions				
P23.00	Cutter mode	Setting range: 0–0x1101 LED ones place: Cutter enabling 0: Disabled 1: Enabled LED tens place: Reserved	0	<input type="radio"/>

Function code	Name	Detailed description	Default value	Modify
		LED hundreds place: Sensor setting 0: Proximity switch 1: Encoder Z pulse LED thousands place: Cutter encoder reset selection 0: The cutter state is reset after the material is transmitted reversely for 5 cm. 1: The cutter state is not reset when the material is transmitted reversely.		
P23.01	Linear speed input	0: Pulse terminal (A2, B2) 1: Digital setting	0	☉
P23.02	Digital setting of linear speed	0.0–600.0 m/min Note: The acceleration and deceleration time of the simulated speed depends on P00.11 and P00.12. The running of the simulated linear speed is independent of whether the cutter is enabled. The simulated linear speed runs even when the cutter stops. Do not set the simulated linear speed too high before the cutter is enabled. Otherwise, shock may be caused.	20.0 m/min	○
P23.03	Cutter diameter	0.00–6553.5 mm	200.0 mm	○
P23.04	Numerator of the cutter reduction gearbox (number of gear teeth on the cutter side)	1–60000	10	☉
P23.05	Denominator of the cutter reduction gearbox (number of gear teeth on the motor side)	1–60000 Note: Number of pulses per revolution of the cutter = $P20.01 \times 4 \times P23.04 / P23.05$	10	☉
P23.06	Diameter of the material feeding encoder roller	0.00–655.35 mm	50.00 mm	○
P23.07	Number of pulses of the material feeding encoder	1–30000 Note: Number of pulses generated when the material feeding roller rotates one circle =	1024	☉

Function code	Name	Detailed description	Default value	Modify
		P23.07×4×P21.11/P21.12		
P23.08	Sensor installation angle	0.0–359.9° (based on the position of the cutting point)	0.0°	⊙
P23.09	Angle of the synchronization area	0.0–300.0° Note: Angle of the synchronization area = Angle between a cutting point and its previous cutting point + Angle between the cutting point and its next cutting point. If the angle of synchronization area is set to 30°, the angle between a cutting point and its previous cutting point is 15°, and that between it and its next cutting point is also 15°. You can increase the angle between two cutting points by modifying P23.17.	30.0°	○
P23.10	Angle increase in the ACC area	0.0–50.0%	0.0%	○
P23.11	Cutting speed increase in the synchronization area	10.0–100.0%	0.0%	○
P23.12	Number of cutters	1–4	1	⊙
P23.13	Reserved	0–1	0	○
P23.14	Speed curve selection	0: Straight line 1: S curve	1	○
P23.15	Cutting length	0–65535	10000	○
P23.16	Unit of cutting length	0: 0.001 mm 1: 0.01 mm 2: 0.1 mm 3: 1 mm	2	⊙
P23.17	Angle of advanced entry into the synchronization area	0.0–90.0°	0°	○
P23.18	Position for returning to zero point	0–359.9° (take the position of the cutting point as 0°)	180.0°	○
P23.19	Pulse threshold	0–1000	20	○

DSV110 Servo Drive for Flying Shears

Function code	Name	Detailed description	Default value	Modify
	for sensor correction	<p>Note: If the difference between the number of cutter pulses (detected by the sensor between two cuttings) and that of pulses per revolution of the cutter (P20.01×4×P23.04/P23.05) is greater than the value of this parameter, the current cutter position is corrected based on the step set in P23.20. If the difference is smaller than the value of this parameter, no correction is performed. The position of the cutter may be changed during the correction, which may affect the accuracy of the current cutting.</p>		
P23.20	Max. pulse correction in each revolution	<p>0–1000 Note: Refer to the description of P23.19.</p>	200	○
P23.21	Angle threshold for cutter position deviation alarm	<p>0–60.0° Note: If the difference between the number of cutter pulses (detected by the sensor between two cuttings) and that of pulses per revolution of the cutter (P20.01×4×P23.04/P23.05) is greater than the value of this parameter (P23.21/360×P20.01×4×P23.04/P23.05) for three consecutive times, the ECUT6 fault is reported.</p>	10.0°	◎
P23.22	Start speed setting	<p>Ones place: Start tracking option 0: Smooth tracking 1: Direct tracking Tens place: Return-to-zero selection for the first start (in non-color code mode) 0: No auto return-to-zero for the first start 1: Auto return-to-zero for the first start</p>	0x00	○
P23.23	Number of sensor detection software filtering times	0–20: (×125 μs)	3	○
P23.24	Second cutting length	0–65535 (set through terminal #55)	10000	○

Chapter 6 Basic operations

6.1 First power-on

Operation during the first power-on

After checking the wiring and power supply, switch on the air switch of the AC power supply on the input side of the servo drive. After being powered on, the keypad of the servo drive displays "8.8.8.8.8." first, and the contactor is closed properly. When the displayed characters change to the set frequency, the initialization of the servo drive is complete, and the servo drive is in the standby state.

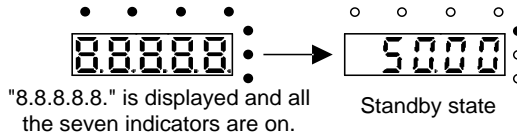

6.2 Commissioning guide

6.2.1 Closed-loop vector control commissioning steps for asynchronous machines

1. Set P00.18 to 1 to restore the factory settings.
2. Set P00.03, P00.04, and motor name plate parameters in the P02 group.
3. Set P00.15 to 2 to perform static parameter autotuning. The obtained parameter values are stored in motor parameters of the P02 group.
4. Check and ensure that the encoder is installed and set properly.

Encoder direction checking and parameter setting: Set the encoder resolution (P20.01), set P00.00 to 2, and set P00.10 to 20 Hz. Run the servo drive, and the motor rotates at 20 Hz. Check whether P18.00 (the speed detected) is correct. If the speed detected is negative, it indicates that the encoder runs reversely. In this case, you need just to set P20.02 to 1. If the deviation of the speed detected is large, it indicates that P20.01 is set incorrectly. Observe whether the value of P18.02 (Encoder Z pulse position value) fluctuates. If it does, it indicates that the encoder encounters interference or P20.01 is set incorrectly. In this case, check the wiring or shield layer.

5. Test the running in the closed-loop vector control mode.

Set P00.00 to 3 to perform the closed-loop vector control. Modify P00.10 and the ASR and ACR PI parameters in the P03 group to ensure the smooth running.

6.2.2 Closed-loop vector control commissioning steps for synchronous machines

1. Set P00.18 to 1 to restore the factory settings.
2. Set P00.00 to 3 (Closed-loop vector control mode), and set P00.03, P00.04, and motor name plate parameters in the P02 group.
3. Set encoder parameters P20.00 and P20.01.
4. Perform initial magnetic pole angle autotuning.

Set P20.11 to 1, 2, or 3 (1 and 3 indicate rotating autotuning, and 2 indicates static autotuning), and then press the **RUN** key to run the servo drive.

(1) Rotating autotuning 1 (P20.11 = 1)

The machine detects the magnetic pole position when the autotuning starts, and then it accelerates to 10 Hz to obtain the magnetic pole position corresponding to the Z pulse of the encoder, and then it decelerates to stop.

If the ENC1O or ENC1D fault occurs in the running, set P20.02 to 1 to perform autotuning again.

After the autotuning is complete, the angle obtained is automatically stored in P20.09 and P20.10.

(2) Static autotuning (P20.11 = 2)

In scenarios where loads can be disconnected, it is recommended that you set P20.11 to 1. In this mode, the angle obtained is more accurate. In scenarios where loads cannot be disconnected, you can set P20.11 to 2. The magnetic pole position obtained through autotuning is stored in P20.09 and P20.10

(3) Rotating autotuning 2 (P20.11 = 3)

The machine performs static autotuning first to obtain the initial magnetic pole angle, and then accelerated to 10 Hz to obtain the magnetic position corresponding to the Z pulse of the encoder and decelerates to stop.

Note:

- If the ENC1D fault (encoder runs reversely) occurs during the autotuning, set P20.02 to 1. If the ENC1O fault (encoder disconnection) occurs, try setting P20.02 to 1, and check and ensure that P20.01 (Encoder resolution) and P02.17 (Number of pole pairs of synchronous motor 1) are set properly. Then perform autotuning.
- After the autotuning is complete, the keypad displays "-END-". Perform autotuning for three consecutive times. If the up and down fluctuation of the initial angle stored in P20.09 and P20.10 is less than 15°, it indicates that the autotuning is properly performed.

5. Test the running in the closed-loop vector control mode.

Modify P00.10 and the ASR and ACR PI parameters in the P03 group to ensure the smooth running. If oscillation occurs, you can decrease the values of P03.00, P03.03, P03.09, and P03.10. If current oscillation occurs in low-speed running, you can modify the low-speed filtering parameter P20.05 (Number of encoder detection filtering times).

Note: After the motor or encoder cables are modified, the direction of the encoder (P20.02) needs to be identified again, and magnetic pole position autotuning needs to be performed again.

6.2.3 Flying cutting commissioning steps

1. Fixed-length cutting mode

- (1) Enable the flying cutting function by setting P23.00 to 1.

- (2) Set the mechanical parameters of the cutter, including P23.03 to P23.05, P23.08, P23.09, and P23.12.

You can adopt the jogging mode to observe the number (P18.10 is the MSD, and P18.11 is the LSD) of encoder feedback pulses per resolution of the cutter detected through sensor signals. The actual deceleration ratio = $(P18.10 - P18.11) / (4 \times P20.01)$. Fine-tune P23.04 and P23.05 according to the actual deceleration ratio. When P23.04 and P23.05 are set properly, P18.28 (pulse deviation corrected through the sensor) is not accumulated. The smaller the value fluctuation of P18.28, the better. If the fluctuation is large, perform mechanical check.

- (3) Check the position of the photoelectric sensor.

Return to zero through the return-to-zero terminal, and observe P18.30 (Cutter position). If the value of P18.30 is the same as that of P23.18 (return-to-zero setting), it indicates that P23.08 is set correctly. Otherwise, reset P23.08. If P23.08 is set incorrectly, the cutting position will be out of the synchronization area.

When the cutter is located at the cutting point (middle point), the value of P18.30 is supposed to be 0. Otherwise, P23.08 is set incorrectly.

- (4) Set the mechanical parameters for material feeding, including P23.06, P23.07, P21.11, and P21.12.

Run the material feeding motor to observe whether the value of P18.31 (Material feeding linear speed) is correct. If the value is incorrect, you need to set the material feeding parameters properly. The actual linear speed must be a positive value (instead of a negative value). Otherwise, set the tens place of P21.01 or re-connect the linear speed detection encoder.

- (5) Handle the interference on the cutter encoder and material feeding encoder.

Check whether the shield layers of the encoders are wired properly. Observe P18.02 (Encoder Z pulse position value). If the value jumps more than 5 pulses, it indicates that there is interference. You need to handle the interference on the encoders. Otherwise, the cutting accuracy may be affected.

Narrow-pulse interference can also be eliminated through software. When you handle the interference through software, you need to set P20.12 and P21.34.

- (6) Set the cutting length and unit through P23.15 and P23.16.

- (7) Test material feeding without paper through simulation

Enable the simulated material feeding speed by setting P23.01 to 1, and set P23.02 (Digital setting of linear speed). Observe P18.26 (Cutting error). If the value meets the requirements, set P23.01 to 0, and you can perform a cutting test with materials.

2. Color code-based cutting mode

Set color code-related parameters, including P22.00 to P22.10.

Each time after receiving a running command signal, the cutter starts to detect color codes and runs at the same speed as the linear speed of the materials. The cutter starts the rotary cutting after detecting the first color code point, and all the subsequent color codes are aligned based on the first detected color code. When the number of missed color codes is greater than P22.10, the servo drive outputs color code missing alarm signals, and perform actions according to the setting of P22.11. Observe P17.23 to see whether the detected color code signal deviation is too large. If yes, adjust the color code sensor to ensure that the value of P17.23 is within a proper range.

3. Commissioning precautions

- (1) Adjust the ASR gain (P03.00–P03.04) and increase the APR gain (P21.03) to reduce the cutting error.
- (2) Set P21.29 (Material feeding speed filtering time) properly to ensure that the cutting accuracy in fast acceleration or deceleration meets requirements.
- (3) When the cutter motor runs first, it automatically searches for reference points. If not reference point is detected, it reports the ECUT5 fault (no reference point found) after running two revolutions.
- (4) After the cutting sensor is adjusted again, you need to set P23.08 (Sensor installation angle) properly again. Then set P23.00 to 0 first and then to 1 to perform the return-to-zero operation again. Otherwise, the ECUT6 fault may be reported.
- (5) Alarm signal output

If (P22.13-P18.29) < P22.14, alarm signal output is enabled. You can set the output signal to be constantly high or pulse signal through P22.15 (setting P22.15 to 1 or 0). If the output signal is set to be pulse signal, you can set the high electrical level time through P22.16 and set the low electrical level time through P22.17. When P22.13 is set to 0, alarm signals are disabled.

Chapter 7 Fault tracking

7.1 Alarm and fault indications

Faults are indicated by indicators. For details, see Chapter 4 "Keypad operation". When the **TRIP** indicator is on, the alarm or fault code displayed on the keypad indicates that the servo drive encounters an exception. You can find out causes and solutions for most of the alarms or faults based on the information provided in this chapter. If you cannot find out the causes of an alarm or fault, contact the local INVT office.

7.2 Fault reset

The servo drive can be reset in various ways, including pressing the **STOP/RST** key on the keypad, digital input, and disconnecting the power supply. After a fault is resolved, you can restart the motor.

7.3 Fault history

The function codes P07.27 to P07.32 record the types of the last six faults. The function codes P07.33 to P07.40, P07.41 to P07.48, and P07.49 to P07.56 record the running data of the servo drive at the last three faults, respectively.

7.4 Servo drive faults and solutions

Perform the following steps after a fault occurs:

1. After a fault occurs on the servo drive, check whether a display exception occurs on the keypad. If yes, contact the INVT office.
2. If no keypad exception occurs, view the corresponding fault recording parameters in the P07 group to understand the actual states at the current fault.
3. Check whether exceptions described in the table in section 7.4.1 occur.
4. Resolve the fault or ask for help.
5. After the fault is resolved, perform fault reset to run the servo drive.

7.4.1 Servo drive faults and solutions

Fault code	Fault type	Possible causes	Solution
OUt1	Inverter unit U phase protection	<ul style="list-style-type: none"> • The acceleration is too fast. • Internal damage is caused on the IGBT of the phase. • The drive cable is not properly connected. • Short-to-ground occurs. 	<ul style="list-style-type: none"> • Increase the acceleration time. • Replace the power unit. • Check the drive cable. • Check whether there are strong interference sources among the peripheral devices.
OUt2	Inverter unit V phase protection		
OUt3	Inverter unit W phase protection		
OV1	ACC overvoltage	<ul style="list-style-type: none"> • Exceptions occur on 	<ul style="list-style-type: none"> • Check the input power

Fault code	Fault type	Possible causes	Solution
OV2	DEC overvoltage	<ul style="list-style-type: none"> the input voltage. 	<ul style="list-style-type: none"> supply.
OV3	Constant-speed overvoltage	<ul style="list-style-type: none"> There is a large amount of fed-back energy. There is a lack of brake components. The dynamic braking function is not enabled. 	<ul style="list-style-type: none"> Check whether the DEC time of the load is too short, or the servo drive is started when the motor is rotating. All a dynamic braking component. Check the settings of related function codes.
OC1	ACC overcurrent	<ul style="list-style-type: none"> The ACC or DEC is too fast. 	<ul style="list-style-type: none"> Increase the ACC or DEC time.
OC2	DEC overcurrent	<ul style="list-style-type: none"> The voltage of the grid is low. The power of the servo drive is low. 	<ul style="list-style-type: none"> Check the input power supply.
OC3	Constant-speed overcurrent	<ul style="list-style-type: none"> The load changes suddenly or exceptions occur on the load. Short-to-ground occurs, or phase loss occurs on the output side. There are strong external interference sources. The overvoltage stall protection function is not enabled. 	<ul style="list-style-type: none"> Use a servo drive with greater power. Check whether the load is short circuited (short to ground or wire-to-wire short circuit) or whether the rotation is blocked. Check the output wiring. Check there is strong interference. Check the settings of related function codes.
UV	Bus undervoltage	<ul style="list-style-type: none"> The voltage of the grid is low. The overvoltage stall protection function is not enabled. 	<ul style="list-style-type: none"> Check the input power supply of the grid. Check the settings of related function codes.
OL1	Motor overload	<ul style="list-style-type: none"> The voltage of the grid is too low. The rated current of the motor is not correctly set. 	<ul style="list-style-type: none"> Check the voltage of the grid. Set the rated current of the motor again. Check the load and

Fault code	Fault type	Possible causes	Solution
		<ul style="list-style-type: none"> The rotation of the motor is blocked or the load suddenly changes too much. 	adjust the torque boost.
OL2	Servo drive overload	<ul style="list-style-type: none"> The ACC is too fast. The rotating motor is restarted. The voltage of the grid is too low. The load is too heavy. The motor power is too large, and the power of the servo drive is too small. 	<ul style="list-style-type: none"> Increase the ACC time. Avoid restarting the motor immediately after it stops. Check the voltage of the grid. Use a servo drive with greater power. Use a motor that meets the operation requirements.
SPI	Phase loss on the input side	The input R, S, or T phase is missed or the fluctuation is large.	<ul style="list-style-type: none"> Check the input power supply. Check the installation wiring.
SPO	Phase loss on the output side	The U, V, or W phase is missed on the output side (or the three phases of the load are seriously asymmetrical).	<ul style="list-style-type: none"> Check the output wiring. Check the motor and cables.
OH1	Rectifier module overheat	<ul style="list-style-type: none"> The vent duct is blocked or the fan is damaged. 	<ul style="list-style-type: none"> Dredge the vent duct or replace the fan. Lower the ambient temperature.
OH2	Inverter module overheat	<ul style="list-style-type: none"> The ambient temperature is too high. The time of overload running is too long. 	
EF	External fault	External fault caused by actions of input terminals.	Check the input of external devices.
CE	485 communication fault	<ul style="list-style-type: none"> The baud rate is improperly set. The communication line is faulty. 	<ul style="list-style-type: none"> Set the baud rate properly. Check the communication port

Fault code	Fault type	Possible causes	Solution
		<ul style="list-style-type: none"> • The communication address is incorrect. • There is strong interference on the communication. 	<p>wiring.</p> <ul style="list-style-type: none"> • Set the communication address correctly. • Change or modify the wiring to improve the anti-interference capability.
ItE	Current detection fault	<ul style="list-style-type: none"> • The control panel connector is in poor contact. • The Hall component is damaged. • The magnifying circuit is abnormal. 	<ul style="list-style-type: none"> • Check the connector and rewire it. • Replace the Hall component. • Replace the main control panel.
tE	Motor autotuning fault	<ul style="list-style-type: none"> • The motor capacity and the servo drive capacity do not match. • The parameters of the motor are not properly set. • The parameter values obtained through autotuning are significantly different from those standard ones. • The autotuning times out. 	<ul style="list-style-type: none"> • Replace the servo drive with one of another model. • Set the model and nameplate parameters of the motor correctly. • Disconnect the load of the motor and perform autotuning again. • Check the cable connection and parameter settings of the motor. • Check whether the upper frequency limit is higher than 2/3 of the rated frequency.
EEP	EEPROM operation fault	<ul style="list-style-type: none"> • Error occurs in writing or reading control parameters. • EEPROM is damaged. 	<ul style="list-style-type: none"> • Press the STOP/RST key to reset. • Replace the main control board.
PIDE	PID feedback disconnection fault	<ul style="list-style-type: none"> • The PID feedback is disconnected. • The PID feedback source cannot be 	<ul style="list-style-type: none"> • Check the PID feedback signal line. • Check the PID feedback source.

Fault code	Fault type	Possible causes	Solution
		found.	
bCE	Brake unit fault	<ul style="list-style-type: none"> • The brake line is faulty or the brake pipe is damaged. • The resistance of the external brake resistor is low. 	<ul style="list-style-type: none"> • Check the brake unit and replace the brake pipe. • Increase the brake resistance.
END	Running time arrival	The actual running time of the servo drive is longer than the preset running time.	Ask the supplier to adjust the preset running time.
OL3	Electronic overload fault	The servo drive generates overload alarms based on the preset value.	Check the load and overload alarm generating threshold.
PCE	Panel communication error	<ul style="list-style-type: none"> • The keypad cable is in poor contact or disconnected. • The keypad cable is too long and so encounters strong interference. • Some of the keypad or mainboard communication circuits are faulty. 	<ul style="list-style-type: none"> • Check the keypad cable to determine whether a fault occurs. • Check the environment and remove interference sources. • Replace hardware and seek maintenance services.
UPE	Parameter upload error	<ul style="list-style-type: none"> • The keypad cable is in poor contact or disconnected. • The keypad cable is too long and so encounters strong interference. • Some of the keypad or mainboard communication circuits are faulty. 	<ul style="list-style-type: none"> • Check the keypad cable to determine whether a fault occurs. • Replace hardware and seek maintenance services. • Replace hardware and seek maintenance services.

Fault code	Fault type	Possible causes	Solution
DNE	Parameter download error	<ul style="list-style-type: none"> • The keypad cable is in poor contact or disconnected. • The keypad cable is too long and so encounters strong interference. • There are errors in the data stored on the keypad. 	<ul style="list-style-type: none"> • Check the keypad cable to determine whether a fault occurs. • Replace hardware and seek maintenance services. • Re-back up the data on the keypad.
E-DP	PROFIBUS communication fault	<ul style="list-style-type: none"> • The communication address is incorrect or the build-out resistor is not removed. • The GSD file of the main station is not properly configured. • The surrounding interference is too strong. 	<ul style="list-style-type: none"> • Check the related settings. • Check the surrounding environment and eliminate interference.
E-NET	Ethernet communication fault	<ul style="list-style-type: none"> • The Ethernet address is incorrectly set. • The Ethernet communication mode is selected incorrectly. • The surrounding interference is too strong. 	<ul style="list-style-type: none"> • Check the related settings. • Check the selection of the communication mode. • Check the surrounding environment and eliminate interference.
E-CAN	CANopen communication fault	<ul style="list-style-type: none"> • The cables are in poor contact or the build-out resistor is not removed. • The communication baud rates are different. • The surrounding interference is too 	<ul style="list-style-type: none"> • Check the cables and remove the build-out resistor. • Set the same baud rate. • Check the surrounding environment and eliminate interference.

Fault code	Fault type	Possible causes	Solution
		strong.	
ETH1	Short-to-ground fault 1	<ul style="list-style-type: none"> • The servo drive is short to ground. • The current detection circuit is faulty. • The actual power setting of the motor is significantly different from the power of the servo drive. 	<ul style="list-style-type: none"> • Check whether the motor is properly wired. • Replace the Hall. • Replace the main control board. • Reset the parameters of the motor.
ETH2	Short-to-ground fault 2	<ul style="list-style-type: none"> • The servo drive output is short to ground. • The current detection circuit is faulty. • The actual power setting of the motor is significantly different from the power of the servo drive. 	<ul style="list-style-type: none"> • Check whether the motor is properly wired. • Replace the Hall. • Replace the main control board. • Reset the parameters of the motor.
dEu	Speed deviation fault	The load is too heavy or the rotation is blocked.	<ul style="list-style-type: none"> • Check the load. Ensure the load is normal. • Increase the detection time. • Check the control parameters.
STo	Misadjustment fault	<ul style="list-style-type: none"> • The control parameters of the synchronous motor are incorrectly set. • The autotuning parameters are 	<ul style="list-style-type: none"> • Check the load. Ensure the load is normal. • Check the control parameters. • Increase the

Fault code	Fault type	Possible causes	Solution
		incorrectly set. <ul style="list-style-type: none"> • The servo drive is not connected to the motor. 	misadjustment detection time.
LL	Electronic underload fault	The servo drive generates underload alarms based on the preset value.	Check the load and underload alarm generating threshold.
ENC1O	Encoder disconnection fault	Errors occur in the line sequence of the encoder, or the signal cable is not properly connected.	Check the wiring of the encoder.
ENC1D	Encoder reverse running fault	The direction in the encoder speed signal is opposite to the running direction of the motor.	Reset the direction of the encoder.
ENC1Z	Encoder Z pulse disconnection fault	The Z signal line is disconnected.	Check the wiring of the Z signal.
OT	Motor overtemperature fault	<ul style="list-style-type: none"> • The motor overtemperature input terminal is enabled. • Exceptions occur on the temperature detection resistor. • The motor runs in the overload state for a long time, or exceptions occur on the motor. 	<ul style="list-style-type: none"> • Check the wiring of the motor overtemperature input terminal (terminal function #57). • Check whether the temperature sensor works properly. • Check and maintain the motor.
ECUT 1	Cutter linear speed too high	The linear speed of the cutter is too high (the linear speed corresponding to P00.03 is too high).	Check the diameter and deceleration ratio setting of the cutter, or reduce the value of P00.03 (Max. output frequency).
ECUT 3	Error setting of the denominator of the material feeding pulse gear ratio	The value of P21.12 (Denominator of the material feeding pulse gear ratio) is set too	Reduce the value of P21.12.

Fault code	Fault type	Possible causes	Solution
		large.	
ECUT 4	Error setting of cutting length	The value of P23.15 (cutting length) is set too small.	Increase the value of P23.15.
ECUT 5	Reference point not found	Reference points cannot be found.	Check whether the proximity switch (sensor) is properly wired. Check whether it is connected to the terminals S6 to S8.
ECUT 6	Cutter reference point deviation	The position of the cutter exceeds the set value of P23.21 for three consecutive times.	Check whether the installation of the sensor causes large fluctuation of P18.28. Check whether the cutter deceleration ratio parameters P23.04 and P23.05 are set properly. Check whether the parameters P23.19 and P23.20 are set properly.
ECUT 7	Color code signal missing fault	The color code signal missing fault occurs. See the parameters P22.10 and P22.11.	Check whether the color code sensor is installed properly.

7.4.2 Other state

Displayed code	State type	Possible cause	Solution
PoFF	System power failure	The system encounters a power outage or the bus voltage is too low.	Check the conditions of the grid.

Chapter 8 Communication protocol

8.1 Introduction to the Modbus protocol

Modbus is a software protocol, a common language used in electronic controllers. By using this protocol, a controller can communicate with other devices through transmission lines. It is a general industrial standard. With this standard, control devices produced by different manufacturers can be connected to form an industrial network and be monitored in a centralized way.

The Modbus protocol provides two transmission modes, namely American Standard Code for Information Interchange (ASCII) and remote terminal units (RTU). On one Modbus network, all the device transmission modes, baud rates, data bits, check bits, end bits, and other basic parameters must be set consistently.

A Modbus network is a control network with one master and multiple slaves, that is, on one Modbus network, there is only one device serving as the master, and other devices are the slaves. The master can communicate with one slave or broadcast messages to all the slaves. For separate access commands, a slave needs to return a response. For broadcasted information, slaves do not need to return responses.

8.2 Application of Modbus

DSV110 servo drives use the RTU mode provided by the Modbus protocol, and RS485 interfaces are used.

8.2.1 RS485

RS485 interfaces work in half-duplex mode and transmit data signals in the differential transmission way, which is also referred to as balanced transmission. An RS485 interface uses a twisted pair, where one wire is defined as A (+), and the other B (-). Generally, if the positive electrical level between the transmission drives A and B ranges from +2 V to +6 V, the logic is "1"; and if it ranges from -2 V to -6 V, the logic is "0".

The 485+ terminal on the terminal block of the servo drive corresponds to A, and 485- corresponds to B.

The communication baud rate (P14.01) indicates the number of bits transmitted in a second, and the unit is bit/s (bps). A higher baud rate indicates faster transmission and poorer anti-interference capability. When a twisted pair of 0.56 mm (24 AWG) is used, the maximum transmission distance varies according to the baud rate, as described in the following table.

Baud rate (bps)	Max. transmission distance	Baud rate (bps)	Max. transmission distance
2400	1800 m	9600	800 m
4800	1200 m	19200	600 m

When RS485 interfaces are used for long-distance communication, it is recommended that you use shielded cables, and use the shield layer as the ground wires.

When there are fewer devices and the transmission distance is short, the whole network works well without terminal load resistors. The performance, however, degrades as the distance increases.

Therefore, it is recommended that you use a 120 Ω terminal resistor when the transmission distance is long.

8.2.1.1 Application to one servo drive

Figure 8-1 is the Modbus wiring diagram of one servo drive and a PC. Generally, PCs do not provide RS485 interfaces, so you need to convert an RS232 interface or USB port of a PC to an RS485 interface. Connect end A of the RS485 interface to the 485+ port on the terminal block of the servo drive, and connect end B to the 485- port. It is recommended that you use shielded twisted pairs. When an RS232-RS485 converter is used, the cable used to connect the RS232 interface of the PC and the converter cannot be longer than 15 m. Use a short cable when possible. It is recommended that you insert the converter directly into the PC. Similarly, when a USB-RS485 converter is used, use a short cable when possible.

After the wiring is complete, select the correct port (the one that connects to the RS232-RS485 converter, for example, COM1) for the upper computer, and set the communication baud rate, data bit check, and other basic parameters to be consistent with those of the servo drive.

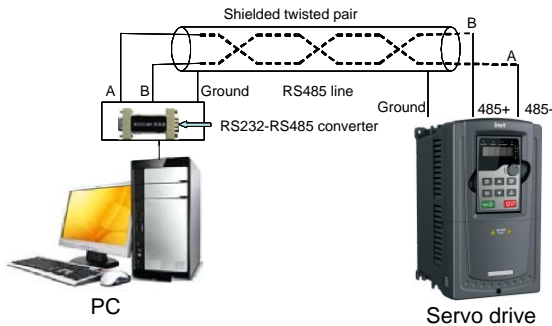

Figure 8-1 Wiring of RS485 applied to one servo drive

8.2.2 RTU mode

8.2.2.1 RTU communication frame structure

When a controller is set to use the RTU communication mode on a Modbus network, every byte (8 bits) in the message includes 2 hexadecimal characters (each includes 4 bits). Compared with the ASCII mode, the RTU mode can transmit more data with the same baud rate.

Code system

- 1 start bit
- 7 or 8 data bits; the minimum valid bit is transmitted first. Each frame domain of 8 bits includes 2 hexadecimal characters (0–9, A–F).
- 1 odd/even check bit; this bit is not provided if no check is needed.
- 1 end bit (with check performed), 2 bits (without check)

Error detection domain

- Cyclic redundancy check (CRC)

The following table describes the data format.

11-bit character frame (Bits 1 to 8 are data bits)

Start bit	BIT1	BIT2	BIT3	BIT4	BIT5	BIT6	BIT7	BIT8	Check bit	End bit
-----------	------	------	------	------	------	------	------	------	-----------	---------

10-bit character frame (Bits 1 to 7 are data bits)

Start bit	BIT1	BIT2	BIT3	BIT4	BIT5	BIT6	BIT7	Check bit	End bit
-----------	------	------	------	------	------	------	------	-----------	---------

In a character frame, only the data bits carry information. The start bit, check bit, and end bit are used to facilitate the transmission of the data bits to the destination device. In practical applications, you must set the data bits, parity check bits, and end bits consistently.

In RTU mode, the transmission of a new frame always starts from an idle time (the transmission time of 3.5 bytes). On a network where the transmission rate is calculated based on the baud rate, the transmission time of 3.5 bytes can be easily obtained. After the idle time ends, the data domains are transmitted in the following sequence: slave address, operation command code, data, and CRC check character. Each byte transmitted in each domain includes 2 hexadecimal characters (0–9, A–F). The network devices always monitor the communication bus. After receiving the first domain (address information), each network device identifies the byte. After the last byte is transmitted, a similar transmission interval (the transmission time of 3.5 bytes) is used to indicate that the transmission of the frame ends. Then, the transmission of a new frame starts.

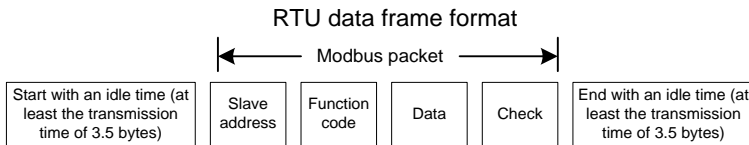

The information of a frame must be transmitted in a continuous data flow. If there is an interval greater than the transmission time of 1.5 bytes before the transmission of the entire frame is complete, the receiving device deletes the incomplete information, and mistakes the subsequent byte for the address domain of a new frame. Similarly, if the transmission interval between two frames is shorter than the transmission time of 3.5 bytes, the receiving device mistakes it for the data of the last frame. The CRC check value is incorrect due to the disorder of the frames, and thus a communication fault occurs.

The following table describes the standard structure of an RTU frame.

START (frame header)	T1-T2-T3-T4 (transmission time of 3.5 bytes)
ADDR (slave address domain)	Communication address: 0–247 (decimal system) (0 is the broadcast address)
CMD (function domain)	03H: read slave parameters 06H: write slave parameters

DATA (N-1) ... DATA (0) (data domain)	Data of 2×N bytes, main content of the communication as well as the core of data exchanging
CRC CHK (LSBs)	Detection value: CRC (16 bits)
CRC CHK (MSBs)	
END (frame tail)	T1-T2-T3-T4 (transmission time of 3.5 bytes)

8.2.2.2 RTU communication frame error check modes

During the transmission of data, errors may occur due to various factors. Without check, the data receiving device cannot identify data errors and may make a wrong response. The wrong response may cause severe problems. Therefore, the data must be checked.

The check is implemented as follows: The transmitter calculates the to-be-transmitted data based on a specific algorithm to obtain a result, adds the result to the rear of the message, and transmits them together. After receiving the message, the receiver calculates the data based on the same algorithm to obtain a result, and compares the result with that transmitted by the transmitter. If the results are the same, the message is correct. Otherwise, the message is considered wrong.

The error check of a frame includes two parts, namely, bit check on individual bytes (that is, odd/even check using the check bit in the character frame), and whole data check (CRC check).

Bit check on individual bytes (odd/even check)

You can select the bit check mode as required, or you can choose not to perform the check, which will affect the check bit setting of each byte.

Definition of even check: Before the data is transmitted, an even check bit is added to indicate whether the number of "1" in the to-be-transmitted data is odd or even. If it is even, the check bit is set to "0"; and if it is odd, the check bit is set to "1".

Definition of odd check: Before the data is transmitted, an odd check bit is added to indicate whether the number of "1" in the to-be-transmitted data is odd or even. If it is odd, the check bit is set to "0"; and if it is even, the check bit is set to "1".

For example, the data bits to be transmitted are "11001110", including five "1". If the even check is applied, the even check bit is set to "1"; and if the odd check is applied, the odd check bit is set to "0". During the transmission of the data, the odd/even check bit is calculated and placed in the check bit of the frame. The receiving device performs the odd/even check after receiving the data. If it finds that the odd/even parity of the data is inconsistent with the preset information, it determines that a communication error occurs.

CRC check mode

A frame in the RTU format includes an error detection domain based on the CRC calculation. The CRC domain checks all the content of the frame. The CRC domain consists of two bytes, including 16

binary bits. It is calculated by the transmitter and added to the frame. The receiver calculates the CRC of the received frame, and compares the result with the value in the received CRC domain. If the two CRC values are not equal to each other, errors occur in the transmission.

During CRC, 0xFFFF is stored first, and then a process is invoked to process a minimum of 6 contiguous bytes in the frame based on the content in the current register. CRC is valid only for the 8-bit data in each character. It is invalid for the start, end, and check bits.

During the generation of the CRC values, the "exclusive or" (XOR) operation is performed on the each 8-bit character and the content in the register. The result is placed in the bits from the least significant bit (LSB) to the most significant bit (MSB), and 0 is placed in the MSB. Then, LSB is detected. If LSB is 1, the XOR operation is performed on the current value in the register and the preset value. If LSB is 0, no operation is performed. This process is repeated 8 times. After the last bit (8th bit) is detected and processed, the XOR operation is performed on the next 8-bit byte and the current content in the register. The final values in the register are the CRC values obtained after operations are performed on all the bytes in the frame.

The calculation adopts the international standard CRC check rule. You can refer to the related standard CRC algorithm to compile the CRC calculation program as required.

The following is a simple CRC calculation function for your reference (using the C programming language):

```
unsigned int crc_cal_value(unsigned char*data_value,unsigned char data_length)
```

```
{
    int i;
    unsigned int crc_value=0xffff;
    while(data_length--)
    {
        crc_value^=*data_value++;
        for(i=0;i<8;i++)
        {
            if(crc_value&0x0001)
                crc_value=(crc_value>>1)^0xa001;
            else
                crc_value=crc_value>>1;
        }
    }
    return(crc_value);
}
```

In the ladder logic, CKSM uses the table look-up method to calculate the CRC value according to the content in the frame. The program of this method is simple, and the calculation is fast, but the ROM space occupied is large. Use this program with caution in scenarios where there are space occupation limits on programs.

8.3 RTU command code and communication data

8.3.1 Command code: 03H, reading N words (continuously reading a maximum of 16 words)

The command code 03H is used by the master to read data from the servo drive. The quantity of data to be read depends on the "data quantity" in the command. A maximum of 16 pieces of data can be read. The addresses of the read parameters must be contiguous. Each piece of data occupies 2 bytes, that is, one word. The command format is presented using the hexadecimal system (a number followed by "H" indicates a hexadecimal value). One hexadecimal value occupies one byte.

The 03H command is used to read information including the parameters and operation state of the servo drive.

For example, starting from the data address of 0004H, to read two contiguous pieces of data (that is, to read content from the data addresses 0004H and 0005H) from the servo drive whose address is 01H, the structure of the frame is described in the following table.

RTU master command (transmitted by the master to the servo drive)

START	T1-T2-T3-T4 (transmission time of 3.5 bytes)
ADDR (address)	01H
CMD (command code)	03H
Most significant byte (MSB) of the start address	00H
Least significant byte (LSB) of the start address	04H
MSB of data quantity	00H
LSB of data quantity	02H
LSB of CRC	85H
MSB of CRC	CAH
END	T1-T2-T3-T4 (transmission time of 3.5 bytes)

The value in START and END is "T1-T2-T3-T4 (transmission time of 3.5 bytes)", indicating that the RS485 needs to stay idle for at least the transmission time of 3.5 bytes. An idle time is required to distinguish on message from another to ensure that the two messages are not regarded as one.

The value of ADDR is 01H, indicating that the command is transmitted to the servo drive whose address is 01H. The ADDR information occupies one byte.

The value of CMD is 03H, indicating that the command is used to read data from the servo drive. The CMD information occupies one byte.

"Start address" indicates that data reading is started from this address. It occupies two bytes, with the

MSB on the left and LSB on the right.

"Data quantity" indicates the quantity of data to be read (unit: word).

The value of "Start address" is 0004H, and that of "Data quantity" is 0002H, indicating that data is to be read from the data addresses of 0004H and 0005H.

CRC check occupies two bytes, with the LSB on the left, and MSB on the right.

RTU slave response (transmitted by the servo drive to the master)

START	T1-T2-T3-T4 (transmission time of 3.5 bytes)
ADDR	01H
CMD	03H
Number of bytes	04H
MSB of data in 0004H	13H
LSB of data in 0004H	88H
MSB of data in 0005H	00H
LSB of data in 0005H	00H
LSB of CRC	7EH
MSB of CRC	9DH
END	T1-T2-T3-T4 (transmission time of 3.5 bytes)

The definition of the response information is described as follows:

The value of ADDR is 01H, indicating that the message is transmitted by the servo drive whose address is 01H. The ADDR information occupies one byte.

The value of CMD is 03H, indicating that the message is a response of the servo drive to the 03H command of the master for reading data. The CMD information occupies one byte.

"Number of bytes" indicates the number of bytes between a byte (not included) and the CRC byte (not included). The value 04 indicates that there are four bytes of data between "Number of bytes" and "LSB of CRC", that is, "MSB of data in 0004H", "LSB of data in 0004H", "MSB of data in 0005H", and "LSB of data in 0005H".

A piece of data is two bytes, with the MSB on the left and LSB on the right. From the response, we can see that the data in 0004H is 1388H, and that in 0005H is 0000H.

CRC check occupies two bytes, with the LSB on the left, and MSB on the right.

8.3.2 Command code: 06H, writing a word

This command is used by the master to write data to the servo drive. One command can be used to write only one piece of data. It is used to modify the parameters and operation mode of the servo drive.

For example, to write 5000 (1388H) to 0004H of the servo drive whose address is 02H, the structure of the frame is described in the following table.

RTU master command (transmitted by the master to the servo drive)

START	T1-T2-T3-T4 (transmission time of 3.5 bytes)
ADDR	02H
CMD	06H
MSB of data writing address	00H
LSB of data writing address	04H
MSB of to-be-written data	13H
LSB of to-be-written data	88H
LSB of CRC	C5H
MSB of CRC	6EH
END	T1-T2-T3-T4 (transmission time of 3.5 bytes)

RTU slave response (transmitted by the servo drive to the master)

START	T1-T2-T3-T4 (transmission time of 3.5 bytes)
ADDR	02H
CMD	06H
MSB of data writing address	00H
LSB of data writing address	04H
MSB of to-be-written data	13H
LSB of to-be-written data	88H
LSB of CRC	C5H
MSB of CRC	6EH
END	T1-T2-T3-T4 (transmission time of 3.5 bytes)

Note:

The sections 8.3.1 and 8.3.2 mainly describes the command formats. For the detailed application, see the examples in section 8.3.8.

8.3.3 Command code: 08H, diagnosis

Sub-function code description

Sub-function code	Description
0000	Return data based on query requests

For example, to query about the circuit detection information about the servo drive whose address is 01H, the query and return strings are the same, and the format is described in the following tables.

RTU master command

START	T1-T2-T3-T4 (transmission time of 3.5 bytes)
ADDR	01H

CMD	08H
MSB of the sub-function code	00H
LSB of the sub-function code	00H
MSB of data	12H
LSB of data	ABH
LSB of CRC CHK	ADH
MSB of CRC CHK	14H
END	T1-T2-T3-T4 (transmission time of 3.5 bytes)

RTU slave response

START	T1-T2-T3-T4 (transmission time of 3.5 bytes)
ADDR	01H
CMD	08H
MSB of the sub-function code	00H
LSB of the sub-function code	00H
MSB of data	12H
LSB of data	ABH
LSB of CRC CHK	ADH
MSB of CRC CHK	14H
END	T1-T2-T3-T4 (transmission time of 3.5 bytes)

8.3.4 Command code: 10H, continuous writing

The command code 10H is used by the master to write data to the servo drive. The quantity of data to be written is determined by "Data quantity", and a maximum of 16 pieces of data can be written.

For example, to write 5000 (1388H) and 50 (0032H) respectively to 0004H and 0005H of the servo drive whose slave address is 02H, the structure of the frame is described in the following table.

RTU master command (transmitted by the master to the servo drive)

START	T1-T2-T3-T4 (transmission time of 3.5 bytes)
ADDR	02H
CMD	10H
MSB of data writing address	00H
LSB of data writing address	04H
MSB of data quantity	00H
LSB of data quantity	02H
Number of bytes	04H
MSB of data to be written to 0004H	13H

LSB of data to be written to 0004H	88H
MSB of data to be written to 0005H	00H
LSB of data to be written to 0005H	32H
LSB of CRC	C5H
MSB of CRC	6EH
END	T1-T2-T3-T4 (transmission time of 3.5 bytes)

RTU slave response (transmitted by the servo drive to the master)

START	T1-T2-T3-T4 (transmission time of 3.5 bytes)
ADDR	02H
CMD	10H
MSB of data writing address	00H
LSB of data writing address	04H
MSB of data quantity	00H
LSB of data quantity	02H
LSB of CRC	C5H
MSB of CRC	6EH
END	T1-T2-T3-T4 (transmission time of 3.5 bytes)

8.3.5 Data address definition

This section describes the address definition of communication data. The addresses are used for controlling the running, obtaining the state information, and setting related function parameters of the servo drive.

8.3.5.1 Function code address representation rules

The address of a function code consists of two bytes, with the MSB on the left and LSB on the right. The MSB ranges from 00 to ffH, and the LSB also ranges from 00 to ffH. The MSB is the hexadecimal form of the group number before the dot mark, and LSB is that of the number behind the dot mark. Take P05.06 as an example, the group number is 05, that is, the MSB of the parameter address is the hexadecimal form of 05; and the number behind the dot mark is 06, that is, the LSB is the hexadecimal form of 06. Therefore, the function code address is 0506H in the hexadecimal form. For P10.01, the parameter address is 0A01H.

Function code	Name	Detailed parameter description	Default value	Modify
P10.00	Simple PLC mode	0: Stop after running once; the inverter stops automatically after running for one cycle, and it can be started only after receiving running command. 1: Keep running in the final value after running once; The inverter keeps the running frequency and direction of the last section after a single cycle. 2: Cyclic running; the inverter enters the next cycle after completing one cycle until receiving stop command and stops.	0	<input type="radio"/>
P10.01	Simple PLC memory selection	0: No memory after power dip 1: Memory after power dip; PLC memories its running stage and running frequency before power dip.	0	<input type="radio"/>

Note:

- The parameters in the P29 group are set by the manufacturer. They cannot be read or modified. Some parameters cannot be modified when the servo drive is running; some cannot be modified regardless of the state of the servo drive. Pay attention to the setting range, unit, and related description of a parameter when modifying it.
- The service life of the Electrically Erasable Programmable Read-Only Memory (EEPROM) may be reduced if it is frequently used for storage. For users, some function codes do not need to be stored during communication. The application requirements can be met by modifying the value of the on-chip RAM, that is, modifying the MSB of the corresponding function code address from 0 to 1. For example, if P00.07 is not to be stored in the EEPROM, you need only to modify the value of the RAM, that is, set the address to 8007H. The address can be used only for writing data to the on-chip RAM, and it is invalid when used for reading data.

8.3.5.2 Description of other function code addresses

In addition to modifying the parameters of the servo drive, the master can also control the servo drive, such as start and stop it, and monitor the operation state of the servo drive.

The following table describes other function parameters.

Function	Address	Data description	R/W
Communication-based control command	2000H	0001H: Forward running	R/W
		0002H: Reverse running	
		0003H: Forward jogging	
		0004H: Reverse jogging	
		0005H: Stop	
		0006H: Coast to stop (emergency stop)	
		0007H: Fault reset	

Function	Address	Data description	R/W
		0008H: Jogging to stop	
Communication-based value setting	2001H	Communication-based frequency setting (0–Fmax, unit: 0.01 Hz)	R/W
	2002H	PID setting, range (0–1000, 1000 corresponding to 100.0%)	
	2003H	PID feedback, range (0–1000, 1000 corresponding to 100.0%)	R/W
	2004H	Torque setting (-3000+3000, 1000 corresponding to 100.0% of the rated current of the motor)	R/W
	2005H	Setting of the upper limit of the forward running frequency (0–Fmax, unit: 0.01 Hz)	R/W
	2006H	Setting of the upper limit of the reverse running frequency (0–Fmax, unit: 0.01 Hz)	R/W
	2007H	Upper limit of the electromotion torque (0–3000, 1000 corresponding to 100.0% of the rated current of the servo drive)	R/W
	2008H	Upper limit of the brake torque (0–3000, 1000 corresponding to 100.0% of the rated current of the motor)	R/W
	2009H	Special control command word: Bit0–1: =00: Motor 1 =01: Motor 2 =10: Motor 3 =11: Motor 4 Bit2: =1 Torque control disabled =0: Torque control cannot be disabled Bit3: =1 Power consumption reset to 0 =0: Power consumption not reset Bit4: =1 Pre-excitation =0: Pre-excitation disabled Bit5: =1 DC brake =0: DC brake disabled	R/W
	200AH	Virtual input terminal command, range: 0x000–0x1FF	R/W
	200BH	Virtual output terminal command, range: 0x00–0x0F	R/W
	200CH	Voltage setting (used when V/F separation is implemented) (0–1000, 1000 corresponding to 100.0% of the rated voltage of the motor)	R/W
200DH	AO output setting 1 (-1000+1000, 1000	R/W	

Function	Address	Data description	R/W
		corresponding to 100.0%)	
	200EH	AO output setting 2 (-1000→+1000, 1000 corresponding to 100.0%)	R/W
Servo drive state word 1	2100H	0001H: Forward running	R
		0002H: Reverse running	
		0003H: Stopped	
		0004H: Faulty	
		0005H: POFF	
		0006H: Pre-excited	
Servo drive state word 2	2101H	Bit0: =0: Not ready to run =1: Ready to run Bi1-2: =00: Motor 1 =01: Motor 2 =10: Motor 3 =11: Motor 4 Bit3: =0: Asynchronous machine =1: Synchronous machine Bit4: =0: No overload alarm =1: Overload alarm Bit5-Bit6: =00: Keypad-based control =01: Terminal-based control =10: Communication-based control	R
Servo drive fault code	2102H	See the description of fault types.	R
Servo drive identification code	2103H	DSV110----0x0109	R
Running frequency	3000H	0-Fmax (unit: 0.01Hz)	Compatible with CHF100A and CHV100 communication addresses
Set frequency	3001H	0-Fmax (unit: 0.01Hz)	
Bus voltage	3002H	0.0-2000.0 V (unit: 0.1V)	
Output voltage	3003H	0-1200V (unit: 1V)	
Output current	3004H	0.0-3000.0A (unit: 0.1A)	
Rotating speed	3005H	0-65535 (unit: 1RPM)	
Output power	3006H	-300.0→+300.0% (unit: 0.1%)	
Output torque	3007H	-250.0→+250.0% (unit: 0.1%)	
Closed-loop setting	3008H	-100.0→+100.0% (unit: 0.1%)	
Closed-loop feedback	3009H	-100.0→+100.0% (unit: 0.1%)	
Input state	300AH	000-1FF	
Output state	300BH	000-1FF	
Analog input 1	300CH	0.00-10.00 V (unit: 0.01V)	
Analog input 2	300DH	0.00-10.00 V (unit: 0.01V)	

Function	Address	Data description	R/W
Analog input 3	300EH	-10.00—+10.00 V (unit: 0.01V)	R
Analog input 4	300FH		R
Read input of high-speed pulse 1	3010H	0.00—50.00 kHz (unit: 0.01Hz)	R
Read input of high-speed pulse 2	3011H		R
Read current step of multi-step speed	3012H	0—15	R
Torque setting	3015H	-300.0—+300.0% (unit: 0.1%)	R
Identification code	3016H		R
Fault code	5000H		R

The Read/Write (R/W) characteristics indicate whether a function can be read and written. For example, "Communication-based control command" can be written, and therefore the command code 06H is used to control the servo drive. The R characteristic indicates that a function can only be read, and W indicates that a function can only be written.

Note: Some parameters in the preceding table are valid only after they are enabled. Take the running and stop operations as examples, you need to set "Channel of running commands" (P00.01) to "Communication", and set "Communication running command channel" (P00.02) to the Modbus communication channel. For another example, when modifying "PID setting", you need to set "PID reference source" (P09.00) to Modbus communication.

8.3.6 Fieldbus scale

In practical applications, communication data is represented in the hexadecimal form, but hexadecimal values cannot represent decimals. For example, 50.12 Hz cannot be represented in the hexadecimal form. In such cases, we can multiply 50.12 by 100 to obtain an integer 5012, and then 50.12 can be represented as 1394H (5012 in the decimal form) in the hexadecimal form.

In the process of multiplying a non-integer by a multiple to obtain an integer, the multiple is referred to as a fieldbus scale.

The fieldbus scale depends on the number of decimals in the value specified in "Detailed parameter description" or "Default value". If there are n decimals in the value, the fieldbus scale m is the nth-power of 10. Take the following value as an example, m is 10.

Function code	Name	Detailed parameter description	Default value
P01.20	Wake-up-from-sleep delay	0.0—3600.0s (valid when P01.19 is 2)	0.0s
P01.21	Restart after power cut	0: Restart is disabled 1: Restart is enabled	0

The value specified in "Detailed parameter description" or "Default value" contains one decimal, so the fieldbus scale is 10. If the value received by the upper computer is 50, the value of

"Wake-up-from-sleep delay" of the servo drive is 5.0 (5.0=50/10).

To set the "Wake-up-from-sleep delay" to 5.0s through Modbus communication, you need first to multiply 5.0 by 10 according to the scale to obtain an integer 50, that is, 32H in the hexadecimal form, and then transmit the following write command:

01	06	01 14	00 32	49 E7
Servo drive address	Write command	Parameter address	Parameter data	CRC

After receiving the command, the servo drive converts 50 into 5.0 based on the fieldbus scale, and then sets "Wake-up-from-sleep delay" to 5.0s.

For another example, after the upper computer transmits the "Wake-up-from-sleep delay" parameter read command, the master receives the following response from the servo drive:

01	03	02	00 32	39 91
Servo drive address	Read command	2-byte data	Parameter data	CRC

The parameter data is 0032H, that is, 50, so 5.0 is obtained based on the fieldbus scale (50/10=5.0). In this case, the master identifies that the "Wake-up-from-sleep delay" is 5.0s.

8.3.7 Error message response

Operation errors may occur in communication-based control. For example, some parameters can only be read, but a write command is transmitted. In this case, the servo drive returns an error message response.

Error message responses are transmitted by the servo drive to the master. The following table describes the codes and definitions of the error message responses.

Code	Name	Definition
01H	Invalid command	The command code received by the upper computer is not allowed to be executed. The possible causes are as follows: <ul style="list-style-type: none"> • The function code is applicable only on new devices and is not implemented on this device. • The slave is in the faulty state when processing this request.
02H	Invalid data address	For the servo drive, the data address in the request of the upper computer is not allowed. In particular, the combination of the register address and the number of the to-be-transmitted bytes is invalid.
03H	Invalid data bit	The received data domain contains a value that is not allowed. The value indicates the error of the remaining structure in the combined

Code	Name	Definition
		request. Note: It does not mean that the data item submitted for storage in the register includes a value unexpected by the program.
04H	Operation failure	The parameter is set to an invalid value in the write operation. For example, a function input terminal cannot be set repeatedly.
05H	Password error	The password entered in the password verification address is different from that set in P07.00.
06H	Data frame error	The length of the data frame transmitted by the upper computer is incorrect, or in the RTU format, the value of the CRC check bit is inconsistent with the CRC value calculated by the lower computer
07H	Parameter read-only	The parameter to be modified in the write operation of the upper computer is a read-only parameter.
08H	Parameter cannot be modified in running	The parameter to be modified in the write operation of the upper computer cannot be modified during the running of the servo drive.
09H	Password protection	A user password is set, and the upper computer does not provide the password to unlock the system when performing a read or write operation. The error of "system locked" is reported.

When returning a response, the device uses a function code domain and fault address to indicate whether it is a normal response (no error) or exception response (some errors occur). In a normal response, the device returns the corresponding function code and data address or sub-function code. In an exception response, the device returns a code that is equal to a normal code, but the first bit is logic 1.

For example, if the master device transmits a request message to a slave device for reading a group of function code address data, the code is generated as follows:

0 0 0 0 0 1 1 (03H in the hexadecimal form)

For a normal response, the same code is returned.

For an exception response, the following code is returned:

1 0 0 0 0 1 1 (83H in the hexadecimal form)

In addition to the modification of the code, the slave returns a byte of exception code that describes the cause of the exception. After receiving the exception response, the typical processing of the master device is to transmit the request message again or modify the command based on the fault information.

For example, to set the "Channel of running commands" (P00.01, the parameter address is 0001H) of the servo drive whose address is 01H to 03, the command is as follows:

<u>01</u>	<u>06</u>	<u>00 01</u>	<u>00 03</u>	<u>98 0B</u>
Servo drive address	Write command	Parameter address	Parameter data	CRC

But the setting range of the "Running command channel" is 0 to 2. The value 3 exceeds the setting range. In this case, the servo drive returns an error message response as shown in the following:

<u>01</u>	<u>86</u>	<u>04</u>	<u>43 A3</u>
Servo drive address	Exception response code	Error code	CRC

The exception response code 86H (generated based on the MSB "1" of the write command 06H) indicates that it is an exception response to the write command (06H). The error code is 04H. From the preceding table, we can see that it indicates the error "Operation failure", which means "The parameter is set to an invalid value in the write operation".

8.3.8 Read/Write operation example

For the formats of the read and write commands, see sections 8.3.1 and 8.3.2.

8.3.8.1 Read command 03H examples

Example 1: Read state word 1 of the servo drive whose address is 01H. From the table of other function parameters, we can see that the parameter address of state word 1 of the servo drive is 2100H.

The read command transmitted to the servo drive is as follows:

<u>01</u>	<u>03</u>	<u>21 00</u>	<u>00 01</u>	<u>8E 36</u>
Servo drive address	Read command	Parameter address	Data quantity	CRC

Assume that the following response is returned:

<u>01</u>	<u>03</u>	<u>02</u>	<u>00 03</u>	<u>F8 45</u>
Servo drive address	Read command	Number of bytes	Data content	CRC

The data content returned by the servo drive is 0003H, which indicates that the servo drive is in the stopped state.

Example 2: View information about the servo drive whose address is 03H, including "Type of current fault" (P07.27) to "Type of last but four fault" (P07.32) of which the parameter addresses are 071BH to 0720H (contiguous 6 parameter addresses starting from 071BH).

The command transmitted to the servo drive is as follows:

03 03 07 1B 00 06 B5 59
 Servo drive Read Start 6 parameters in total CRC
 address command address

Assume that the following response is returned:

03 03 0C 00 23 00 23 00 23 00 23 00 23 00 23 00 23 5F D2
Servo drive Read Number of Type of Type of Type of last Type of last Type of last Type of last CRC
address command bytes current fault last fault but one fault but two fault but three fault but four fault

From the returned data, we can see that all the fault types are 0023H, that is, 35 in the decimal form, which means the misadjustment fault (STo)

8.3.8.2 Write command 06H examples

Example 1: Set the servo drive whose address is 03H to be forward running. Refer to the table of other function parameters, the address of "Communication-based control command" is 2000H, and 0001H indicates forward running, as shown in the following figure.

Function	Address	Data description	R/W
Communication-based control command	2000H	0001H: Forward running	R/W
		0002H: Reverse running	
		0003H: Forward jogging	
		0004H: Reverse jogging	
		0005H: Stop	
		0006H: Coast to stop (emergency stop)	
		0007H: Fault reset	
		0008H: Jogging to stop	

The command transmitted by the master is as follows:

03 06 20 00 00 01 42 28
 Servo drive Write Parameter Forward CRC
 address command address running

If the operation is successful, the following response is returned (same as the command transmitted by the master):

03 06 20 00 00 01 42 28
 Servo drive Write Parameter Forward CRC
 address command address running

Example 2: Set the "Max. output frequency" of the servo drive whose address is 03H to 100 Hz.

Function code	Name	Detailed parameter description	Default value	Modify
P00.03	Max. output frequency	Used to set the max. output frequency of the inverter. It is the basis of frequency setup and the acceleration/deceleration. Setting range: Max (P00.04, 10.00)–630.00Hz	50.00Hz	©

From the number of decimals, we can see that the fieldbus scale of the "Max. output frequency" (P00.03) is 100. Multiply 100 Hz by 100. The value 10000 is obtained, and it is 2710H in the hexadecimal form.

The command transmitted by the master is as follows:

<u>03</u>	<u>06</u>	<u>00 03</u>	<u>27 10</u>	<u>62 14</u>
Servo drive address	Write command	Parameter address	Parameter data	CRC

If the operation is successful, the following response is returned (same as the command transmitted by the master):

<u>03</u>	<u>06</u>	<u>00 03</u>	<u>27 10</u>	<u>62 14</u>
Servo drive address	Write command	Parameter address	Parameter data	CRC

Note: In the preceding command description, spaces are added to a command just for explanatory purposes. In practical applications, no space is required in the commands.

8.3.8.3 Continuously write command 10H examples

Example 1: Set the servo drive whose address is 01H to be forward running at the frequency of 10 Hz. Refer to the table of other function parameters, the address of "Communication-based control command" is 2000H, 0001H indicates forward running, and the address of "Communication-based value setting" is 2001H, as shown in the following figure. 10 Hz is 03E8H in the hexadecimal form.

Function	Address	Data description	R/W
Communication-based control command	2000H	0001H: Forward running	R/W
		0002H: Reverse running	
		0003H: Forward jogging	
		0004H: Reverse jogging	
		0005H: Stop	
		0006H: Coast to stop (emergency stop)	
		0007H: Fault reset	
		0008H: Jogging to stop	
Communication-based value setting	2001H	Communication-based frequency setting (0 – Fmax, unit: 0.01 Hz)	R/W
	2002H	PID setting, range (0–1000, 1000 corresponding to 100.0%)	

In the actual operation, set P00.01 to 2 and P00.06 to 8.

The command transmitted by the master is as follows:

01 **10** **20 00** **00 02** **04** **00 01** **03 E8** **3B 10**
 Servo drive Continuous Parameter Parameter Number of Forward 10 Hz CRC
 address write address quantity bytes running

If the operation is successful, the following response is returned:

01 **10** **20 00** **00 02** **4A 08**
 Servo drive Continuous Parameter Parameter CRC
 address write address quantity

Example 2: Set "ACC time 1" of the servo drive whose address is 01H to 10s, and "DEC time 1" to 20s.

Function code	Name	Detailed parameter description	Default value	Modify
P00.11	ACC time 1	Indicates the time the servo drive takes to accelerate from 0 Hz to P00.03 (Max. output frequency). Setting range: 0.0–3600.0s	Depend on model	<input type="radio"/>
P00.12	DEC time 1	Indicates the time the servo drive takes to decelerate from P00.03 (Max. output frequency) to 0 Hz. Setting range: 0.0–3600.0s	Depend on model	<input type="radio"/>

The address of P00.11 is 000B, 10s is 0064H in the hexadecimal form, and 20s is 00C8H in the hexadecimal form.

The command transmitted by the master is as follows:

01 **10** **00 0B** **00 02** **04** **00 64** **00 C8** **F2 55**
 Servo drive Continuous Parameter Parameter Number of 10s 20s CRC
 address write address quantity bytes

If the operation is successful, the following response is returned:

01 **10** **00 0B** **00 02** **30 0A**
 Servo drive Continuous Parameter Parameter CRC
 address write address quantity

Note: In the preceding command description, spaces are added to a command just for explanatory purposes. In practical applications, no space is required in the commands.

8.3.8.4 Modbus communication commissioning example

A PC is used as the host, an RS232-RS485 converter is used for signal conversion, and the PC serial port used by the converter is COM1 (an RS232 port). The upper computer commissioning software is the serial port commissioning assistant Commix, which can be downloaded from the Internet. Download a version that can automatically execute the CRC check function. The following figure

shows the interface of Commix.



First, set the serial port to **COM1**. Then, set the baud rate consistently with P14.01. The data bits, check bits, and end bits must be set consistently with P14.02. If the RTU mode is selected, you need to select the hexadecimal form **Input HEX**. To set the software to automatically execute the CRC function, you need to select **ModbusRTU**, select **CRC16 (MODBU SRTU)**, and set the start byte to **1**. After the auto CRC check function is enabled, do not enter CRC information in commands. Otherwise, command errors may occur due to repeated CRC check.

The commissioning command to set the servo drive whose address is 03H to be forward running is as follows (see example 1 in section 8.3.8.2):

<u>03</u>	<u>06</u>	<u>20 00</u>	<u>00 01</u>	<u>42 28</u>
Servo drive address	Write command	Parameter address	Forward running	CRC

Note:

1. Set the address (P14.00) of the servo drive to 03.
2. Set "Channel of running commands" (P00.01) to "Communication", and set "Communication channel of running commands" (P00.02) to the Modbus communication channel.
3. Click **Send**. If the line configuration and settings are correct, a response transmitted by the servo drive.

8.4 Common communication faults

Common communication faults include the following:

- No response is returned.
- The servo drive returns an exception response.

Possible causes of no response include the following:

- The serial port is set incorrectly. For example, the converter uses the serial port COM1, but

COM2 is selected for the communication.

- The settings of the baud rates, data bits, end bits, and check bits are inconsistent with those set on the servo drive.
- The positive pole (+) and negative pole (-) of the RS485 bus are connected reversely.
- The 485 terminal cap on the terminal block of the servo drive is not plugged in.

Appendix A Extension cards

A.1 Optional PROFIBUS cards

See the manual of optional PROFIBUS cards.

A.2 Optional CANopen cards

See the manual of optional CANopen cards.

Appendix B Technical data

B.1 Grid specifications

Grid voltage	AC 3PH 380V (-15%)—440V (+10%)
Short-circuit capacity	According to the definition in IEC 60439-1, the maximum allowable short-circuit current at the incoming end is 100 kA. Therefore, the servo drive is applicable to scenarios where the transmitted current in the circuit is no larger than 100 kA when the servo drive runs at the maximum rated voltage.
Frequency	50/60 Hz \pm 5%, with a maximum change rate of 20%/s

B.2 Motor connection data

Motor type	Asynchronous induction motor or permanent-magnet synchronous motor
Voltage	0–U ₁ (rated voltage of the motor), 3PH symmetrical, U _{max} (rated voltage of the servo drive) at the field-weakening point
Short-circuit protection	The short-circuit protection for the motor output meets the requirements of IEC 61800-5-1.
Frequency	0–400 Hz
Frequency resolution	0.01 Hz
Current	See the rated current.
Power limit	1.5 times of the rated power of the motor
Field-weakening point	10–400 Hz
Carrier frequency	4, 8, 12, or 15 kHz

B.2.1 EMC compatibility and motor cable length

The following table describes the maximum motor cable lengths that meet the requirements of the EU EMC directive (2004/108/EC) when the carrier frequency is 4 kHz.

All models (with external EMC filters)	Maximum motor cable length (m)
Environment category II (C3)	30
Environment category I (C2)	30

You can learn the maximum length of the motor cable through the running parameters of the servo drive. To understand the accurate maximum cable length for using an external EMC filter, contact the local INVT office.

For description about the environment categories I (C2) and II (C3), see section "EMC regulations".

B.3 Application standards

The following table describes the standards that the servo drives comply with.

EN/ISO 13849-1:2008	Safety of machinery—Safety-related parts of control systems—Part 1: General principles for design
---------------------	---

IEC/EN 60204-1:2006	Safety of machinery—Electrical equipment of machines. Part 1: General requirements
IEC/EN 62061:2005	Safety of machinery—Safety-related functional safety of electrical, electronic, and programmable electronic control systems
IEC/EN 61800-3:2004	Adjustable speed electrical power drive systems—Part 3:EMC requirements and specific test methods
IEC/EN 61800-5-1:2007	Adjustable speed electrical power drive systems—Part 5-1: Safety requirements—Electrical, thermal and energy
IEC/EN 61800-5-2:2007	Adjustable speed electrical power drive systems—Part 5-2: Safety requirements—Function

B.3.1 CE marking

The CE marking on the name plate of a servo drive indicates that the servo drive is CE-compliant, meeting the regulations of the European low-voltage directive (2006/95/EC) and EMC directive (2004/108/EC).

B.3.2 EMC compliance declaration

European Union (EU) stipulates that the electric and electrical devices sold in Europe cannot generate electromagnetic disturbance that exceeds the limits stipulated in related standards, and can work properly in environments with certain electromagnetic interference. The EMC product standard (EN 61800-3:2004) describes the EMC standards and specific test methods for adjustable speed electrical power drive systems. Products must strictly follow these EMC regulations.

B.4 EMC regulations

The EMC product standard (EN 61800-3:2004) describes the EMC requirements on servo drives.

Application environment categories

Category I: Civilian environments, including application scenarios where servo drives are directly connected to the civil power supply low-voltage grids without intermediate transformers

Category II: All environments except those in Category I.

Servo drive categories

C1: Rated voltage lower than 1000 V, applied to environments of Category I.

C2: Rated voltage lower than 1000 V, non-plug, socket, or mobile devices; power drive systems that must be installed and operated by specialized personnel when applied to environments of Category I

Note: The EMC standard IEC/EN 61800-3 no longer restricts the power distribution of servo drives, but it specifies their use, installation, and commissioning. Specialized personnel or organizations must have the necessary skills (including the EMC-related knowledge) for installing and/or performing commissioning on the electrical drive systems.

C3: Rated voltage lower than 1000 V, applied to environments of Category II. They cannot be applied to environments of Category I.

C4: Rated voltage higher than 1000 V, or rated current higher or equal to 400 A, applied to complex systems in environments of Category II.

B.4.1 Servo drive category of C2

The induction disturbance limit meets the following stipulations:

1. Select an optional EMC filter according to Appendix D and install it following the description in the EMC filter manual.
2. Select the motor and control cables according to the description in the manual.
3. Install the servo drive according to the description in the manual.
4. For the maximum length of the motor cable when the switching frequency is 4 kHz, see section "EMC compatibility and motor cable length".



Currently in environments in China, the inverter may generate radio interference, and you need to take measures to reduce the interference.

B.4.2 Servo drive category of C3

The anti-interference performance of the servo drive meets the requirements of environment Category II in the IEC/EN 61800-3 standard.

The induction disturbance limit meets the following stipulations:

1. Select an optional EMC filter according to Appendix D and install it following the description in the EMC filter manual.
2. Select the motor and control cables according to the description in the manual.
3. Install the servo drive according to the description in the manual.
4. For the maximum length of the motor cable when the switching frequency is 4 kHz, see section "EMC compatibility and motor cable length".



Servo drives of C3 category cannot be applied to civilian low-voltage common grids. When applied to such grids, the servo drive may generate radio frequency electromagnetic interference.

Appendix C Dimension diagrams

C.1 Keypad structure

C.1.1 Structure diagram

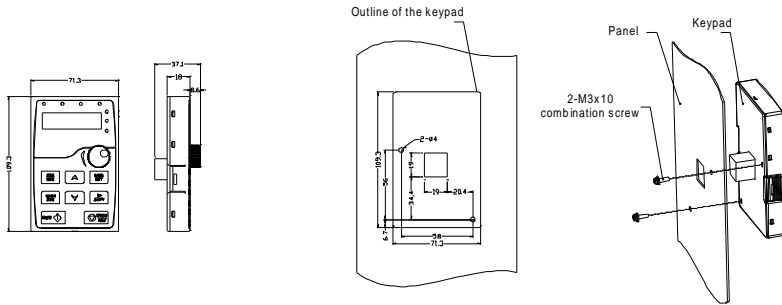

Installation hole dimensions and diagram of key installation without bracket

Figure C-1 Structure diagram

C.1.2 Keypad installation bracket

Note: When installing a keypad externally, you can directly use M3 thread screws to fix it or use a keypad mounting bracket. For servo drives of 380 V, 1.5 to 30 kW, keypad mounting brackets are optional, and you need to purchase them if required. For those of 380 V, 37 to 315 kW, the keypad can be installed externally by using the standard keypad mounting bracket or an optional one.

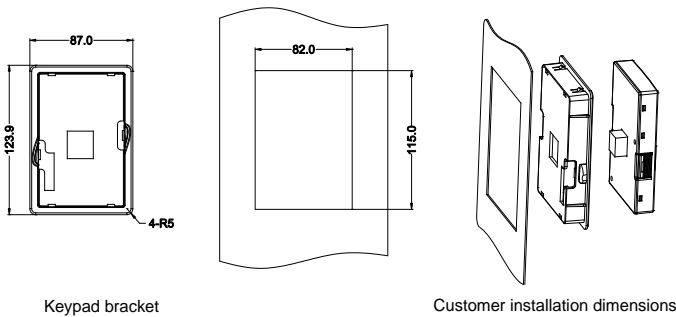

Figure C-2 Keypad installation bracket (optional) for servo drives of 380 V, 4 to 315 kW

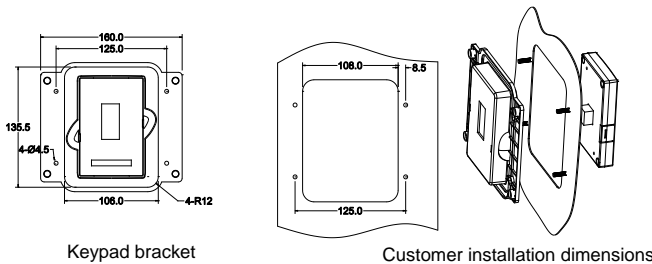

Figure C-3 Keypad installation bracket (standard) for servo drives of 380 V, 37 to 315 kW

C.2 Dimension diagrams

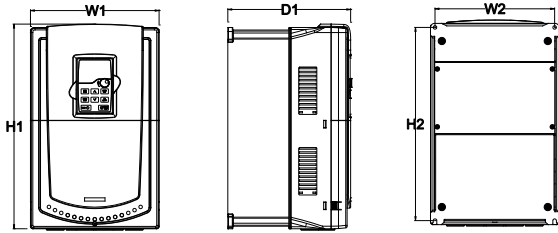

Figure C-4 Wall-mounting diagram of servo drives of 380 V, 4 to 30 kW

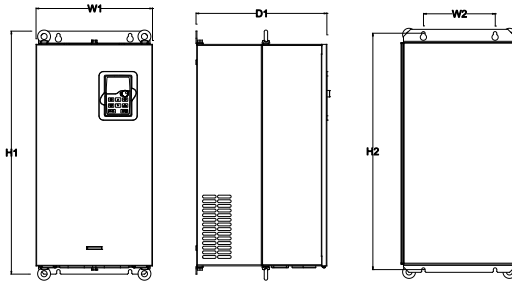

Figure C-5 Wall-mounting diagram of servo drives of 380 V, 37 to 110 kW

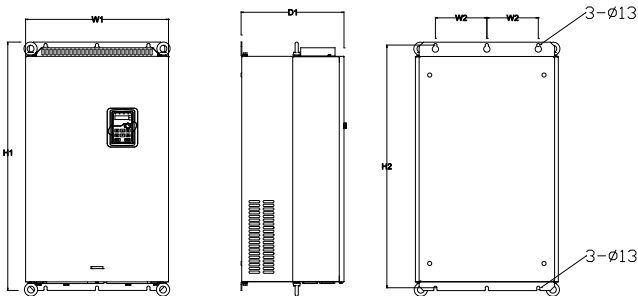

Figure C-6 Wall-mounting diagram of servo drives of 380 V, 132 to 200 kW

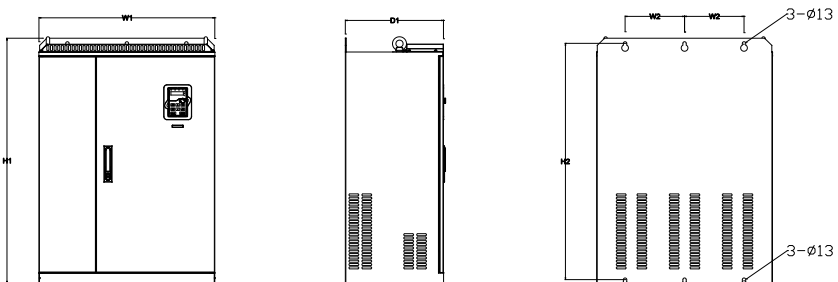

Figure C-7 Wall-mounting diagram of servo drives of 380 V, 220 to 315 kW

Wall-mounting dimensions of 380 V servo drives (unit: mm)

Servo drive specification	W1	W2	H1	H2	D1	Installation hole
4kW–5.5kW	146	131	263	243.5	181	6
7.5kW–11kW	170	151	331.5	303.5	216	6
15kW–18.5kW	230	210	342	311	216	6
22kW–30kW	255	237	407	384	245	7
37kW–55kW	270	130	555	540	325	7
75kW–110kW	325	200	680	661	365	9.5
132kW–200kW	500	180	870	850	360	11
220kW–315kW	680	230	960	926	380	13

Appendix D Optional peripheral accessories

D.1 Wiring of peripheral accessories

The following figure shows the external wiring of a DSV110 flying shear-dedicated servo drive.

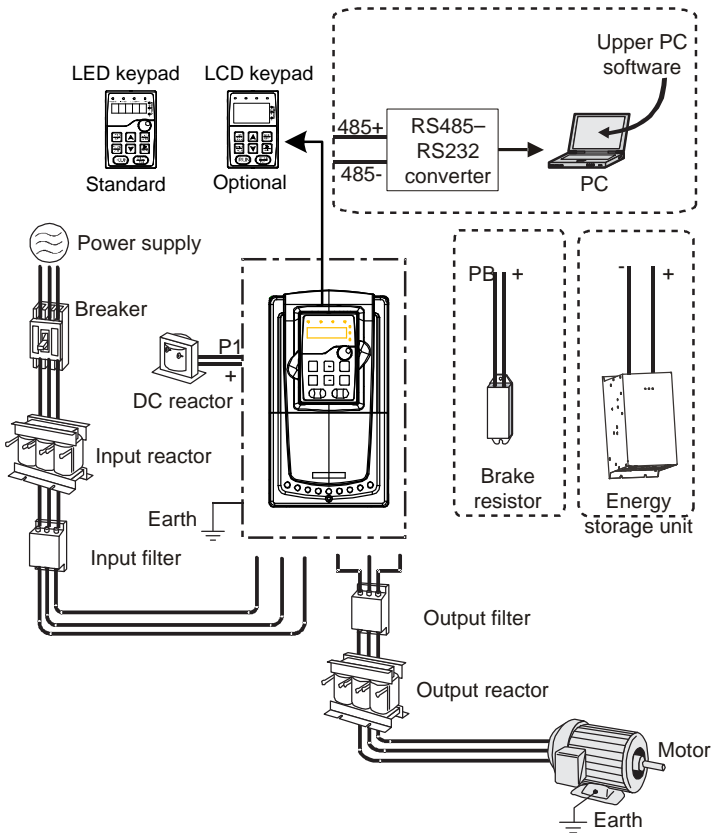

Figure D-1 Diagram of external wiring

Note:

- Servo drives of 380 V, 30 kW or lower are equipped with built-in brake units.
- Only servo drives of 380 V, 37 kW or higher are equipped with the P1 terminal that can be used to connect an external DC reactor.
- INVT CBU series energy storage units are used. For details, see section D.2.









Image	Name	Description
	Cable	Accessory for signal transmission
	Breaker	Device for electric shock prevention and protection against short-to-ground that may cause current leakage and fire. Select residual-current circuit breakers (RCCBs) that are applicable to the servo drive and can restrict high-order harmonics, and of which the rated sensitive current for one servo drive is larger than 30 mA.
	Input reactor	Accessories used to improve the current adjustment coefficient on the input side of the servo drive, and thus restrict high-order harmonic currents. Servo drives of 380 V, 37 kW or higher and 660 V series can be connected to external DC reactors.
	DC reactor	
	Input filter	Accessory that restricts the electromagnetic interference generated by the servo drive and transmitted to the public grid through the power cable. Try to install the input filter near the input terminal side of the servo drive.
	Brake resistor	Accessories used to consume the regenerative energy of the motor to reduce the deceleration time. Servo drives of 380 V, 30 kW or lower need only to be configured with brake resistors.
	Output filter	Accessory used to restrict interference generated in the wiring area on the output side of the servo drive. Try to install the output filter near the output terminal side of the servo drive.
	Output reactor	Accessory used to lengthen the valid transmission distance of the servo drive, which effectively restrict the transient high voltage generated during the switch-on and switch-off of the IGBT module of the servo

Image	Name	Description
		drive.
	Energy storage unit	Accessories used to absorb the regenerative energy to reduce the deceleration time, and release the stored energy to reduce the acceleration time.

D.2 Capacitor components

They consume a large amount of energy and generate a large amount of heat during dynamic braking. Capacitor components can be used to absorb and release energy to conserve energy during the running of flying shears.

1. Capacitor component models

Model	Capacity (mF)	Corresponding power level	Buffer resistor	Structure
CBU-005C-4	5	30 kW or lower	One wire-wound resistor: 80 W, 20 Ω, ±5%,	C1
CBU-010C-4	10	37 kW, 45 kW		C2
CBU-015C-4	15	55 kW	One wire-wound resistor: 3000 W, 10 Ω, ±5%	C3
CBU-020C-4	20	75 kW		C4
CBU-025C-4	25	90 kW		C5

Ordering instruction: A capacitor component model includes a capacitor component and a buffer resistor.

2. Wiring diagram of a capacitor component

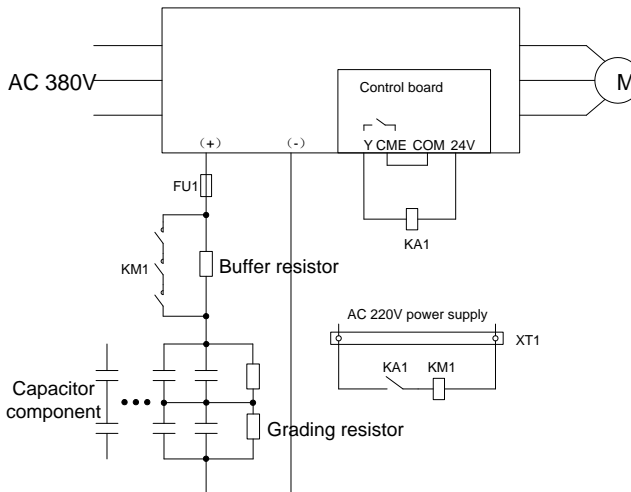

Figure D-2 Wiring diagram of a capacitor component

2. Installation dimensions

(1) C1 installation dimensions

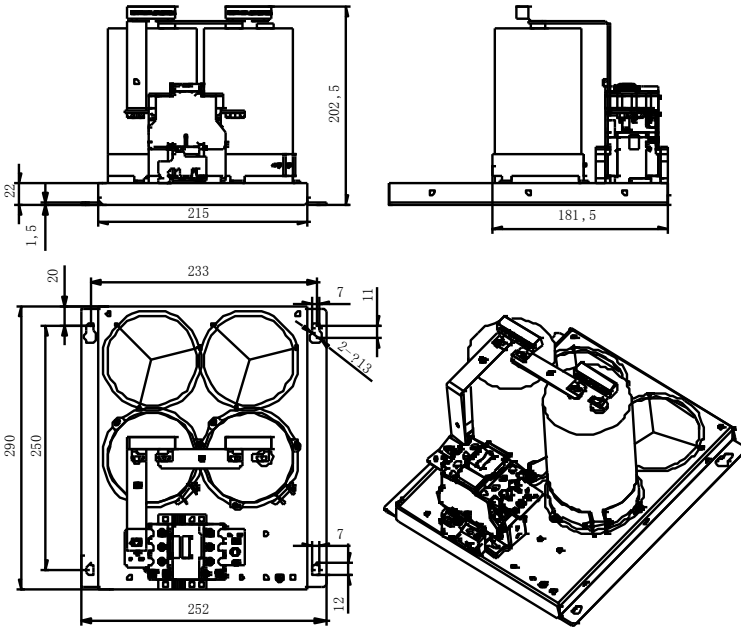

Figure D-3 Installation dimensions of 2 capacitor components

(2) C1 installation dimensions

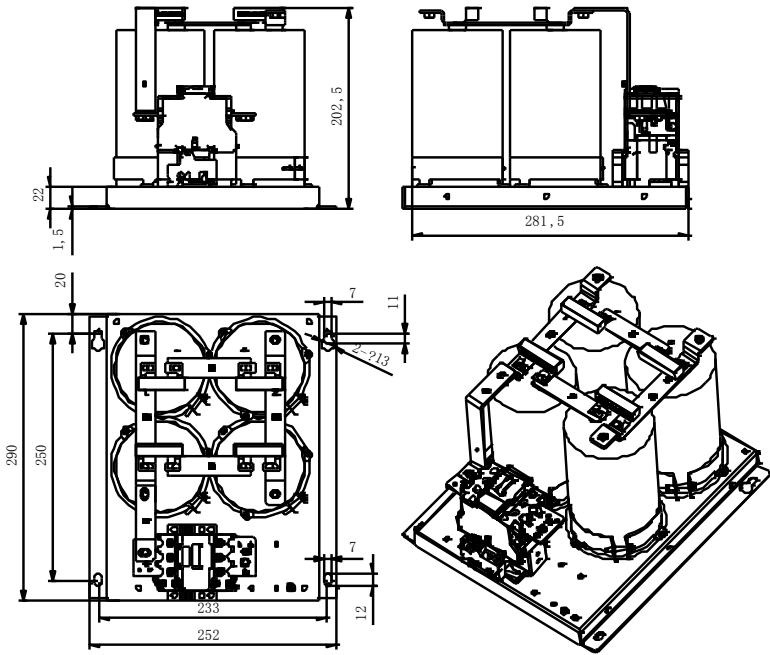

Figure D-4 Installation dimensions of 4 capacitor components

(3) C3 installation dimensions

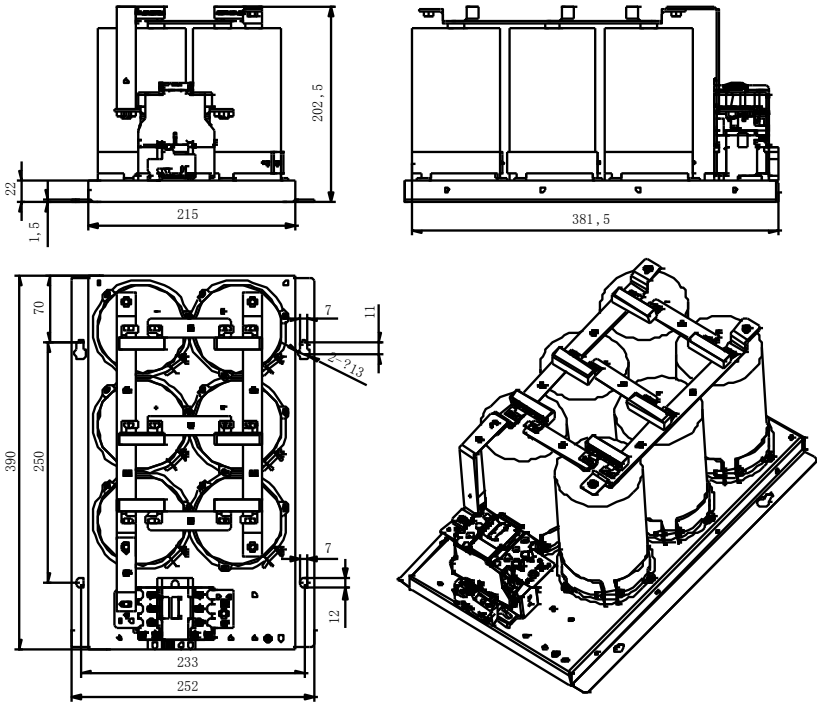

Figure D-5 Installation dimensions of 6 capacitor components

(4) C4 installation dimensions

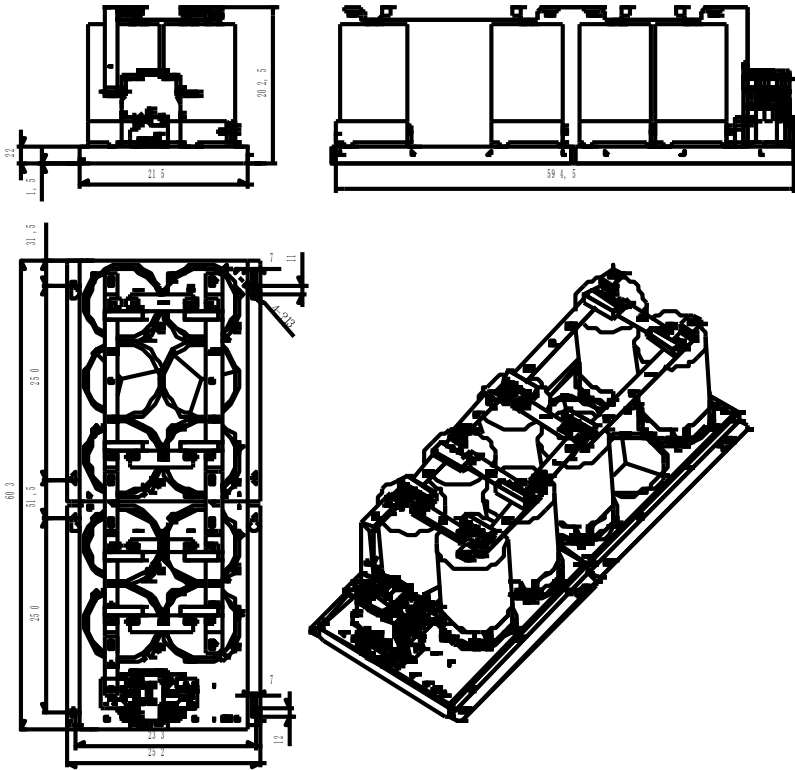

Figure D-8 Installation dimensions of 8 capacitor components

(5) C5 installation dimensions

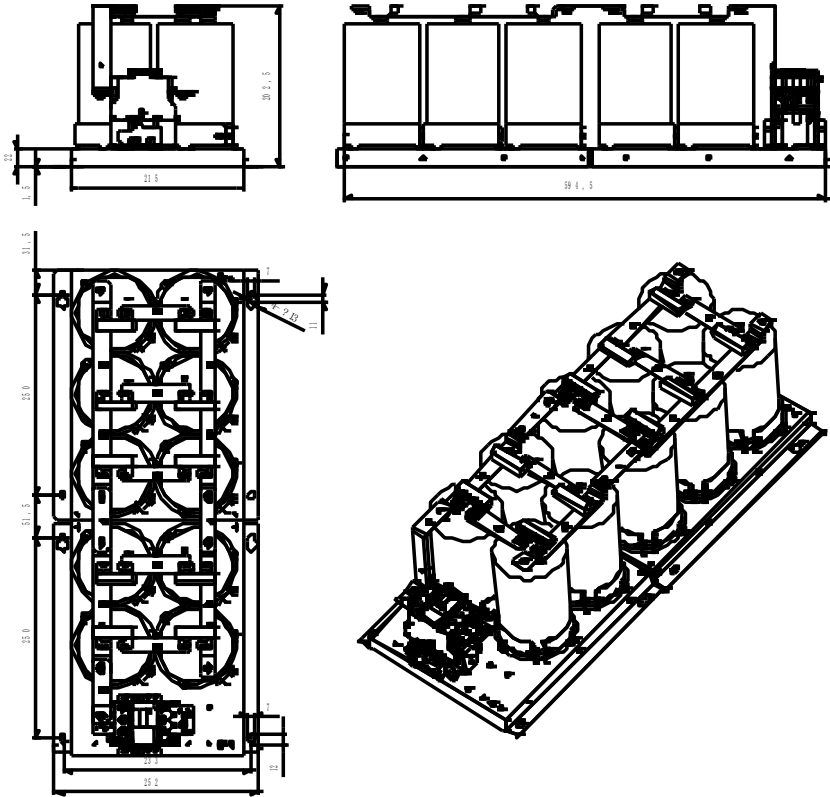

Figure D-7 Installation dimensions of 10 capacitor components

(6) C6 installation dimensions

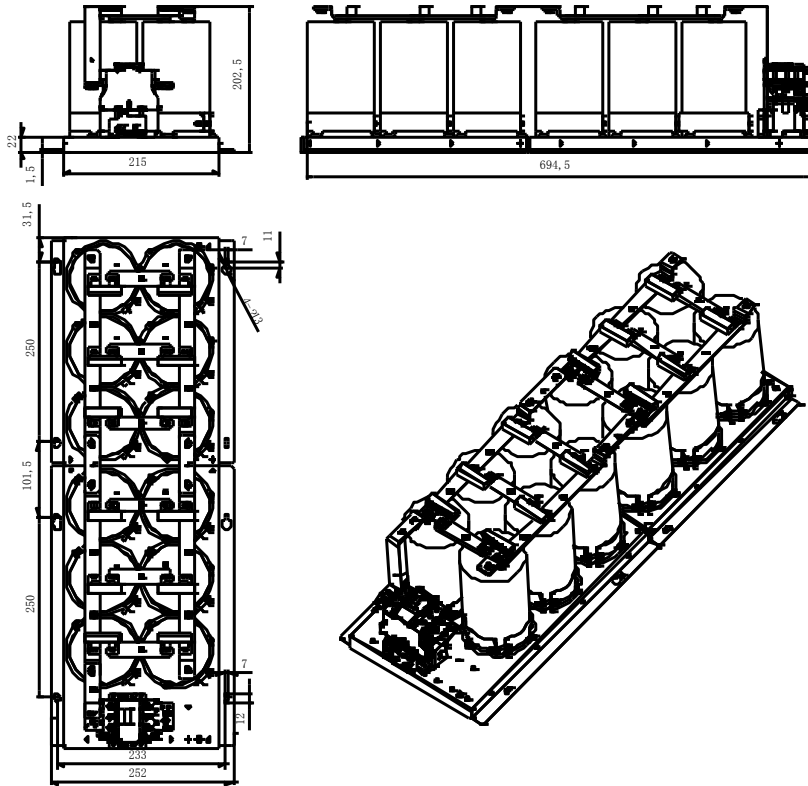

Figure D-8 Installation dimensions of 12 capacitor components

D.3 Brake resistors

Model	Brake unit type	Resistance applicable for 100% brake torque (Ω)	Power of brake resistor (W)	Min. allowable brake resistance (Ω)
DSV110-004G-4	Built-in brake unit	60	1000	50
DSV110-5R5G-4		50	1000	47
DSV110-7R5G-4		40	1500	38
DSV110-011G-4		40	2000	27
DSV110-015G-4		27	2000	23
DSV110-018G-4		27	4000	19
DSV110-022G-4		20	6000	17
DSV110-030G-4		17	9600	17



Service line:86-755-86312859 E-mail:overseas@invt.com.cn Website:www.invt.com

The products are owned by **Shenzhen INVT Electric Co.,Ltd.**

Two companies are commissioned to manufacture: (For product code, refer to the 2nd/3rd place of S/N on the name plate.)

Shenzhen INVT Electric Co.,Ltd. (origin code: 01)

Address: 4# Building, Gaofa Industrial Park, Longjing,
Nanshan District, Shenzhen, China

INVT Power Electronics (Suzhou) Co.,Ltd (origin code: 06)

Address: 1# Kunlun Mountain Road, Science&Technology Town,
Gaoxin District, Suzhou, Jiangsu, China

Industrial Automation : ■ Frequency Inverter ■ Servo & Motion Control ■ Motor & Electric Spindle ■ PLC

■ HMI ■ Intelligent Elevator Control System ■ Traction Drive

Electric Power : ■ SVG ■ Solar Inverter ■ UPS ■ Online Energy Management System



66007-00332

INVT Copyright.

Information may be subject to change without notice during product improving.

201808 (V1.0)